

The background of the entire page is a dynamic, abstract composition of thick, expressive brushstrokes in a wide array of colors including yellow, green, blue, red, purple, and orange, all set against a solid black background. The strokes are layered and textured, creating a sense of movement and depth.

EXHB

THE EXHIBITORS' HANDBOOK 2023

theexhibitorshandbook.ca









powerful
VISUAL
COMMUNICATIONS
solutions

VISUAL COMMUNICATIONS solutions

The Exhibitors' Handbook® offers the best and widest range of visual communications solutions for corporate interiors, retail environments, tradeshow and events.

Our collection includes portable displays, light boxes, outdoor displays, fabric structures, exhibit kits and more!

SYMBOL KEY

-  product made in North America
-  economy product
-  standard product
-  premium product
-  recyclable product (does not include graphic)
-  product comes with a carry bag or case
-  rental product
-  new product

WARRANTY KEY

-  lifetime limited warranty (frame)
-  5 year limited warranty (frame)
-  1 year limited warranty (frame)
-  90 day limited warranty (frame)
-  graphics limited 1 year warranty (indoor products)
-  graphics limited 6 month warranty (outdoor & table throw products)



Contents

Portable Displays & Systems

- 06** BANNERS
BANNER STANDS & SYSTEMS
RETRACTABLE | TELESCOPIC | SPRING BACK
- 16** FABRIC BANNERS & LIGHT BOXES
FORMULATE® | VECTOR FRAME™
- 20** HANGING & WALL MOUNTED DISPLAYS
HANGING BANNERS | VECTOR FRAME™ EDGE | TRAPPA
- 24** OUTDOOR DISPLAYS
TENTS | FLAGS | SIGNS
- 36** TABLE THROWS & RUNNERS
- 38** FOLDING PANEL TABLETOP DISPLAYS
- 40** EXPANDING DISPLAY SYSTEMS
HOPUP™ TENSION FABRIC DISPLAYS
- 46** EMBRACE™ PUSH-FIT SEG FABRIC DISPLAYS
- 52** XCLAIM™ FABRIC POPUP DISPLAYS
- 60** COYOTE™ POPUP DISPLAY SYSTEMS

Contents

Fabric Displays & Structures

64

MODULATE® MAGNETIC
BANNERS | 10', 20' 30' RECONFIGURABLE KITS

70

FORMULATE® ESSENTIAL
BANNERS | TABLETOP DISPLAYS | 8' & 10' DISPLAYS

74

FORMULATE MASTER
TABLETOP DISPLAYS | 8', 10', 20' DISPLAYS | ACCENTS

82

FORMULATE DESIGNER SERIES
10', 20' 30' KITS

90

FORMULATE FUSION 20' X 20' ISLAND KITS

96

FORMULATE HANGING &
ARCHITECTURAL STRUCTURES
HANGING SIGNS | TOWERS | ARCHES | CONFERENCE WALLS

Contents

Modular Exhibit Systems

108

HYBRID PRO™ MODULAR DISPLAYS
10', 20' & ISLAND KITS

120

VECTOR FRAME™ MODULAR DISPLAYS
BANNERS | 10', 20' KITS | HANGING LIGHT BOXES | TOWERS | ACCENTS

132

ORBITAL EXPRESS™ TRUSS DISPLAYS
10', 20' & ISLANDS KITS | ACCENTS

Accents & Accessories

142

COUNTERS

144

INFO CENTERS
TABLET STANDS | KIOSKS | SIGNS STANDS | LITERATURE RACKS

151

LIGHTING

153

CASES



BANNER STANDS

and systems

BLADE LITE

Superior style and value!

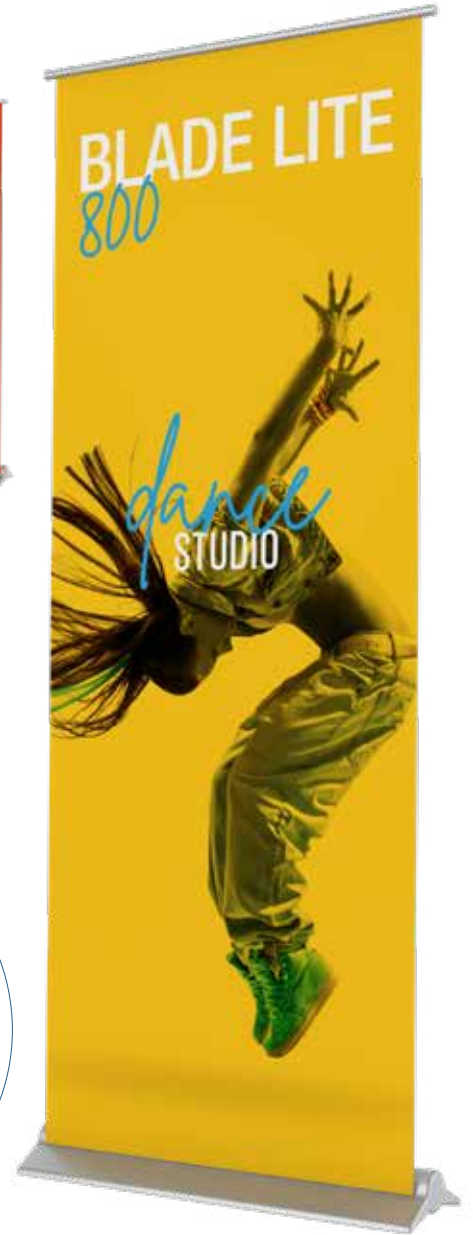

- graphic materials: vinyl, premium fabric, supreme melinex
- toolless quick rail combines the ease of a snap rail with the reassurance of an adhesive fixing
- weighted base for stability
- adjustable leveling feet
- 400mm features 4-piece pole, all other sizes feature hybrid bungee/telescopic pole.

code	width	height	assembled dimensions
BLD-LT-400-1	15.75"	69.375"	Ⓜ 17.75" w x 72.13" h x 8.6" d
BLD-LT-600-1	23.5"	69" - 83.25"	Ⓜ 25.5" w x 86" h x 8.6" d
BLD-LT-800-1	31.5"	60" - 83.25"	Ⓜ 33.5" w x 86" h x 8.6" d
BLD-LT-850-1	33.5"	60" - 83.25"	Ⓜ 35.4" w x 86" h x 8.6" d
BLD-LT-920-1	36"	60" - 83.25"	Ⓜ 38" w x 86" h x 8.6" d
BLD-LT-1000-1	39.25"	60" - 83.25"	Ⓜ 41.3" w x 86" h x 8.6" d
BLD-LT-1200-1	47.25"	60" - 83.25"	Ⓜ 49" w x 86" h x 8.6" d
BLD-LT-1500-1	59"	60" - 83.25"	Ⓜ 61" w x 86" h x 8.6" d

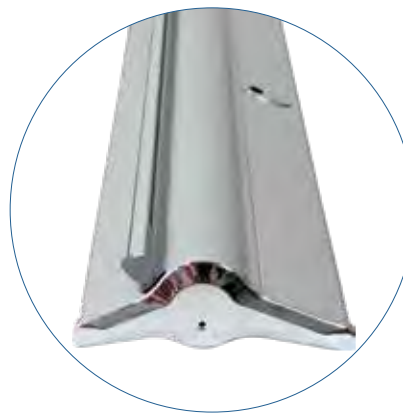

hybrid bungee/telescopic pole for easy assembly



comes with carry bag with inner protective foam padding



illuminate your graphic with optional LED lighting LUM-LED3-ORL-B

ORIENT 1



- graphic materials: vinyl, premium fabric, supreme melinex
- anodized silver or black base options
- toolless quick rail combines the ease of a snap rail with the reassurance of an adhesive fixing
- molded end caps
- adjustable feet on base
- hybrid bungee/telescopic pole

code	width	height	assembled dimensions
ONT-800-S/B-4	31.5"	60.5" - 83.25"	Ⓞ 32.68"w x 84.75"h x 7.08"d
ONT-850-S/B-4	33.5"	60.5" - 83.25"	Ⓞ 34.65"w x 86"h x 7.08"d
ONT-920-S/B-4	35.5"	60.5" - 83.25"	Ⓞ 37.49"w x 84.75"h x 7.08"d
ONT-1000-S/B-4	39.5"	60.5" - 83.25"	Ⓞ 40.55"w x 84.75"h x 7.08"d



silver or black base options!

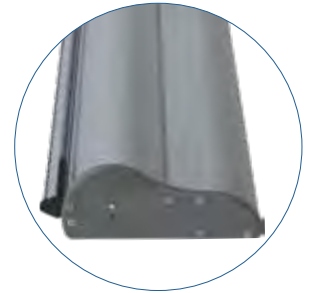

choose from vinyl, premium fabric or supreme melinex graphic material!

ORIENT 2



double-sided graphic

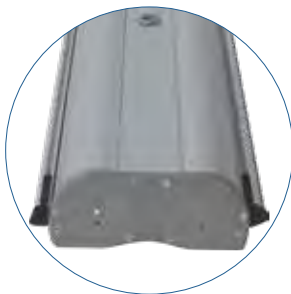

- graphic materials: vinyl, premium fabric, supreme melinex
- anodized silver base
- toolless quick rail combines the ease of a snap rail with the reassurance of an adhesive fixing
- molded end caps
- adjustable feet on base
- hybrid bungee/telescopic pole

code	width	height	assembled dimensions
ONT-800-DBL-S-4	31.5"	60.5" - 83.25"	Ⓞ 32.68"w x 84.75"h x 7.28"d
ONT-920-DBL-S-4	35.5"	60.5" - 83.25"	Ⓞ 37.49"w x 84.75"h x 7.28"d

ORIENT ORGANIC



maple woodgrain base



- graphic materials: vinyl, premium fabric, supreme melinex
- maple woodgrain base finish
- toolless quick rail combines the ease of a snap rail with the reassurance of an adhesive fixing
- plastic end caps
- adjustable feet on base
- hybrid bungee/telescopic pole

code	width	height	assembled dimensions
ONT-850-DW	33.5"	60.5" - 83.25"	Ⓞ 35"w x 63.5" - 88.25"h x 7.25"d

ROLLUP



black base

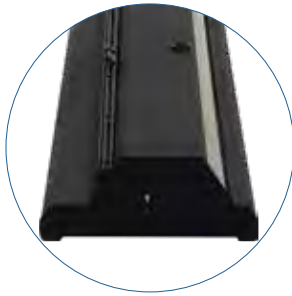

- graphic materials: vinyl, premium fabric, supreme melinex
- black finish
- premium grip rail
- adjustable feet on base
- bungee pole

code	width	height	assembled dimensions
RU-S1-4	34.5"	84.5"	Ⓞ 32.68" w x 84.75" h x 7.08" d

PACIFIC

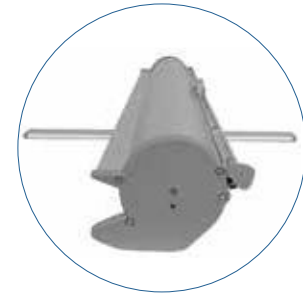

- graphic materials: vinyl, premium fabric, supreme melinex
- anodized silver base
- molded end caps
- swivel-out foot
- 3-piece bungee pole

code	width	height	assembled dimensions
PAC-800-S-2	31.5"	83.75"	Ⓞ 32.5" w x 86.25" h x 16" d
PAC-920-S-2	35.5"	83.75"	Ⓞ 37.49" w x 84.75" h x 7.28" d
PAC-1000-S-2	39.25"	83.75"	Ⓞ 37.49" w x 84.75" h x 7.28" d

CONTENDER



silver or black base options!

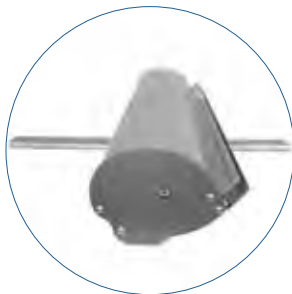

- graphic materials: vinyl, premium fabric, supreme melinex
- swivel-out foot
- silver or black base options
- laser cut steel ends & 3-piece pole

code	width	height	assembled dimensions
CN-24-S/B	23.5"	77.5" - 105"	Ⓞ 24.5" w x 77.5" - 105" h x 16" d
CN-30-S/B	29.5"	77.5" - 105"	Ⓞ 30.5" w x 77.5" - 105" h x 16" d
CN-36-S/B	35.5"	77.5" - 105"	Ⓞ 36.5" w x 77.5" - 105" h x 16" d
CN-48-B	47.5"	77.5" - 105"	Ⓞ 48.5" w x 77.5" - 105" h x 16" d

MERLIN



interchangeable graphic cassette included

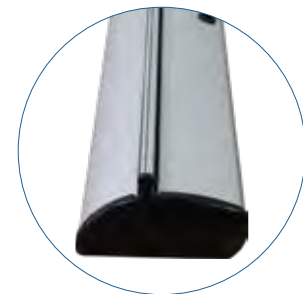

- graphic materials: vinyl, premium fabric, supreme melinex
- anodized silver base
- snap top graphic rail
- hybrid bungee/telescopic pole

code	width	height	assembled dimensions
MRLN-850-2	33.5"	60.5" - 88"	Ⓞ 32.68" w x 84.75" h x 7.28" d

ILLUMISTAND

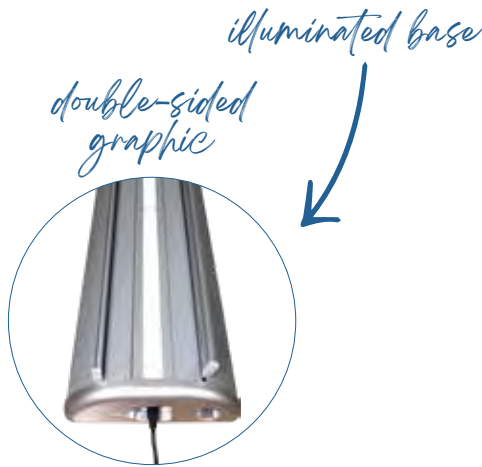

- graphic materials: vinyl, premium fabric, supreme melinex
- anodized silver base with gray molded endcaps
- LED lights in base shine upwards to illuminate graphics, UL/CE certified
- graphics (2) printed on backlit banner film for optimal glow
- bungee pole with graphic slider
- comes with a premium padded carry bag with strap

code	width	height	assembled dimensions
ILLUM-800-1	31"	78"	Ⓞ 37.49" w x 84.75" h x 7.28" d

BARRACUDA

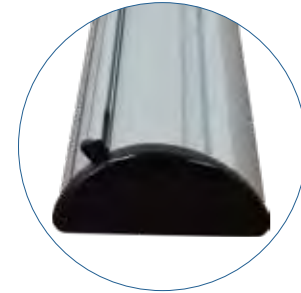

- graphic materials: vinyl, premium fabric, supreme melinex
- anodized silver base
- toolless quick rail
- graphic tensioner
- adjustable feet on base
- hybrid bungee/telescopic pole

code	width	height	assembled dimensions
BCD-600-S-1	23.5"	66.5" - 83"	Ⓞ 26" w x 69" - 85.75" h x 7.87" d
BCD-800-S-1	31.5"	60" - 83"	Ⓞ 33.75" w x 62.75" - 85.75" h x 7.87" d
BCD-850-S-1	33.5"	60" - 83"	Ⓞ 35.5" w x 62.75" - 85.75" h x 7.87" d
BCD-920-S-1	35.5"	60" - 83"	Ⓞ 38.58" w x 62.75" - 85.75" h x 7.87" d
BCD-1200-S-1	47.25"	60" - 83"	Ⓞ 49.5" w x 62.75" - 85.75" h x 7.87" d

ADVANCE



- graphic materials: vinyl, premium fabric, supreme melinex
- graphic tensioner
- integrated pole storage
- interchangeable graphic cassette
- telescopic pole

code	width	height	assembled dimensions
ADV-800-S	31.5"	29.5" - 83.35"	Ⓞ 34.25" w x 31.5" - 87" h x 11.61" d

IMAGINE

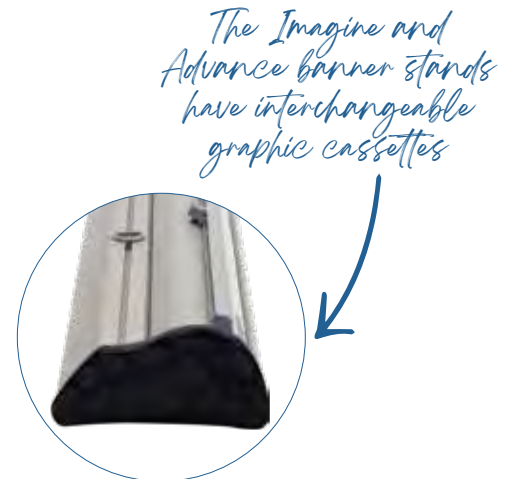

- graphic materials: vinyl, premium fabric, supreme melinex
- graphic tensioner
- integrated pole storage
- interchangeable graphic cassette
- telescopic pole with premium grip rail

code	width	height	assembled dimensions
IMG-800-S	31.5"	30.5" - 83.35"	Ⓞ 34.25" w x 31.5" - 87" h x 8.5" d
IMG-850-S	33.5"	30.5" - 83.35"	Ⓞ 36.25" w x 30.5" - 87" h x 8.5" d

Wide range of size options!



- graphic materials: vinyl, premium fabric, supreme melinex (melinex not available for 1500mm)
- anodized silver or black base options (800mm only)
- swivel feet & snap-top graphic rail
- 400mm unit has 4-piece pole; 600mm, 800mm, 850mm and 920mm units have one bungee pole, 1200mm and 1500mm have two bungee poles

code	width	height	assembled dimensions
MSQT-400	15.75"	15.25" - 62.5"	⊗ 16.68"w x 66.43"h x 11.5"d
MSQT-600	23.5"	78.5"	⊗ 24.5"w x 82.87"h x 11.5"d
MSQT-800 MSQT-800-B	31.5"	78.5"	⊗ 32"w x 82.87"h x 11.2"d
MSQT-850	33.5"	78.5"	⊗ 34.43"w x 82.87"h x 11.5"d
MSQT-920	36"	78.5"	⊗ 36.87"w x 82.87"h x 11.5"d
MSQT-1200	47.25"	78.5"	⊗ 48.25"w x 82.87"h x 11.2"d
MSQT-1500	59"	78.5"	⊗ 59.5"w x 82.87"h x 11.2"d

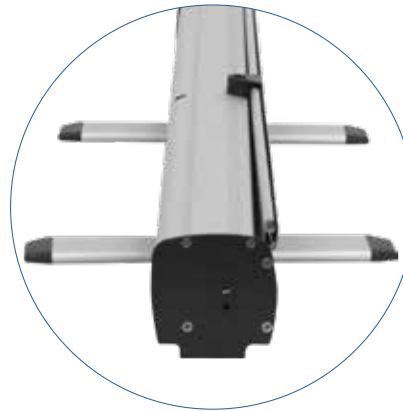

hybrid bungee/telescopic pole for easy assembly



comes with carry bag with inner protective foam padding



black base option available for Mosquito 800

GIANT MOSQUITO



- graphic materials: vinyl, premium fabric, supreme melinex
- anodized silver base
- swivel feet
- snap top graphic rail
- adjustable telescopic pole
- heavy duty, weighted stand

code	width	height	assembled dimensions
MSQT-GIANT-920-S	36"	68" - 122"	Ⓞ, 37" w x 72" - 125" h x 15.75" d

MOSQUITO LITE

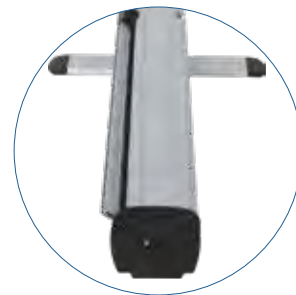

- graphic materials: vinyl, premium fabric, supreme melinex
- standard graphic height = 78.5"
- anodized silver base
- swivel foot
- snap top graphic rail
- 3-piece bungee pole

code	width	height	assembled dimensions
MSQT-LT-800	31.5"	78.5"	Ⓞ, 32.17" w x 82.28" h x 14" d

DRAGON FLY



- graphic materials: vinyl, premium fabric, supreme melinex
- snap top graphic rail
- swivel feet
- 3-piece bungee pole
- new base

code	width	height	assembled dimensions
DRAGON-FLY-1	33.25"	79"	Ⓞ, 34.25" w x 83" h x 15.75" d

QUICKSTAND

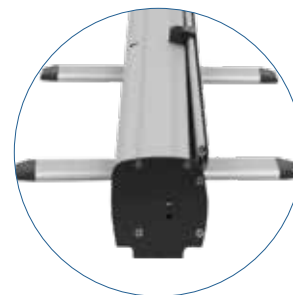

- graphic materials: vinyl, premium fabric, supreme melinex
- anodized silver base
- kit includes 1 Mosquito 800 banner stand, 1 OCB-2 banner stand case, and 1 Slimline LED Spot Light
- swivel feet
- snap top graphic rail
- 3-piece bungee pole

code	width	height	assembled dimensions
QWK-STND-S	31.5"	78.5"	Ⓞ, 32" w x 82.87" h x 11.2" d

PHOENIX



- graphic materials: vinyl, premium fabric, supreme melinex
- anodized silver base
- swivel feet
- snap top graphic rail
- 3-piece bungee pole

code	width	height	assembled dimensions
PHX-850-S	33.5"	79"	Ⓞ 34.65"w x 81.5"h x 13.78"d

PHOENIX MINI



- graphic materials: vinyl, premium fabric, supreme melinex
- anodized silver base
- 2-piece pole & optional extenders for added height
- comes complete with carry bag
- tabletop or skinny full-height banner stand

code	width	height options	assembled dimensions
PHX-400-S	15.5"	16.5", 31.5"	Ⓞ 17"w x 34.25"h x 4.88"d
PHX-400-S-2P	15.5"	47.25", 63"	Ⓞ 17"w x 65.5"h x 4.88"d

BREEZE



- graphic materials: vinyl, premium fabric, supreme melinex
- retractable tabletop banner stand
- anodized silver base
- ideal for promotional use

code	width	height	assembled dimensions
BREZ-1-S	8.375"	11.75"	Ⓞ 8.38"w x 13"h x 3"d
BREZ-2-S	11"	17"	Ⓞ 11"w x 19"h x 3"d

STELLAR



- graphic materials: vinyl, premium fabric, supreme melinex
- retractable tabletop banner stand
- injection molded/white plastic base
- ideal for promotional use

code	width	height	assembled dimensions
STLLR-LTR	8.5"	11"	Ⓞ 9.13"w x 11.75"h x 3"d
STLLR-TBLD	11"	17"	Ⓞ 11.6"w x 17.75"h x 3"d

PEGASUS SUPREME



- graphic materials: display poly or oxford fabric
- single or double-sided graphics
- linking connectors attach multiple units together
- telescopic poles for adjustable graphic width and height

code	width	height	assembled dimensions
PGSUS3-S/B	63.5" - 117.5"	82.75" - 119"	70.63" - 125.43"w x 82.09" - 123.66"h x 25.6"d



extend your banner with a linking kit

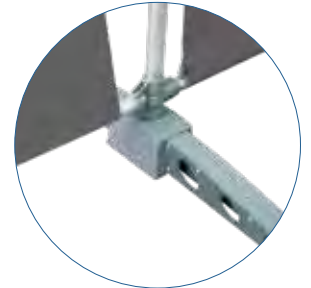

PEGASUS STANDARD



- graphic materials: display poly or oxford fabric
- single or double-sided graphics
- linking connectors attach multiple units together
- telescopic poles for adjustable graphic width and height

code	width	height	assembled dimensions
PGSUS2-S/B	51.5" - 94"	67.75" - 96.5"	58.66" - 102.36"w x 70.87" - 100.2"h x 25.6"d



PEGASUS LINKING KIT



- graphic materials: display poly or oxford fabric
- linking connectors attach multiple Pegasus units together
- extension kit includes 2 horizontal poles, 1 vertical pole, pole locks, 2 linking connectors & 1 foot

code	width	height	assembled dimensions
PGSUS3-EXT-S/B	63.5" - 117.5"	82.75" - 119"	70.63" - 125.43"w x 82.09" - 123.66"h x 25.6"d
PGSUS2-EXT-S/B	51.5" - 94"	67.75" - 96.5"	58.66" - 102.36"w x 70.87" - 100.2"h x 25.6"d

TRIO 2

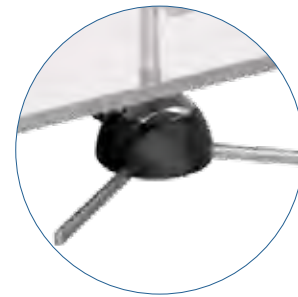

- graphic materials: vinyl, premium fabric, supreme melinex
- tri-pod banner stand
- hardware supports your choice of one or two graphics
- snap top rails make for easy graphic replacements
- hybrid bungee-telescoping pole
- quick and easy to set-up

code	width	height	assembled dimensions
TRIO-2	31.5" or 36"	51.5" - 76"	31.5" - 36.25"w x 58.5" - 82.75"h x 19.25"d

LIGHTNING



- graphic materials: vinyl or supreme melinex
- snap-lock graphic rails
- lightweight aluminum components
- 3-piece bungee pole
- includes carry bag

code	width	height	assembled dimensions
LTNG	31"	77"	📏 31" w x 77" h x 20.25" d

L-MINI



- graphic material: vinyl
- tabletop tension banner stand
- adhesive rail
- anodized silver finish
- hardware and graphics pack into and ship in one tube

code	width	height options	assembled dimensions
L-MINI	14.5"	26.88"	📏 14.25" w x 26.88" h x 6" d

X-TEND



- graphic material: vinyl
- x frame banner stand
- durable black fiberglass arms
- #2 grommets in corners
- single-sided graphic
- basic carry bag included

code	width	height	assembled dimensions
X-TEND-1	23.63"	63"	📏 23.62" w x 63" h x 24" d
X-TEND-2	27.5"	70.88"	📏 27.56" w x 70.87" h x 24" d
X-TEND-3	31.5"	70.88"	📏 31.5" w x 70.87" h x 24" d
X-TEND-4	31.5"	78.25"	📏 31.5" w x 78.75" h x 24" d
X-TEND-5	33.5"	78.25"	📏 33.75" w x 80.25" h x 27" d



easy-to-assemble, lightweight x-frame!

Fabric Banner Displays

Formulate® Essential banner displays feature basic tubular frames coupled with pillowcase fabric graphics. The economy tube frames come with a one year limited warranty. Simply pull the graphic over the frame.



FORMULATE ESSENTIAL BANNERS

- standard depth = 14.75"
- offered in seven widths
- straight aluminum tube frame
- rounded corners
- bungee cords for easy assembly
- sturdy feet anchor the display
- comes with single or double-sided pillowcase fabric graphic
- comes with carry bag



bungee corded poles allow for simple assembly



easy-to-apply pillowcase fabric graphics

code	width	height	assembled dimensions
FMLT-E-S-600-2	23.5"	91.63"	⊗ 25"w x 92"h x 15"d
FMLT-E-S-800-2	31.5"	91.63"	⊗ 33"w x 92"h x 15"d
FMLT-E-S-850-2	33.5"	91.63"	⊗ 35"w x 92"h x 15"d
FMLT-E-S-920-2	36.5"	91.63"	⊗ 37.75"w x 92"h x 15"d
FMLT-E-S-1000-2	39.5"	91.63"	⊗ 40.9"w x 92"h x 15"d
FMLT-E-S-1200-2	47.25"	91.63"	⊗ 48.75"w x 92"h x 15"d
FMLT-E-S-1500-2	59"	91.63"	⊗ 60.5"w x 92"h x 15"d

comes with height extender

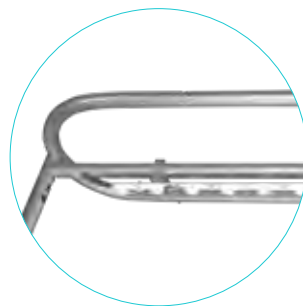
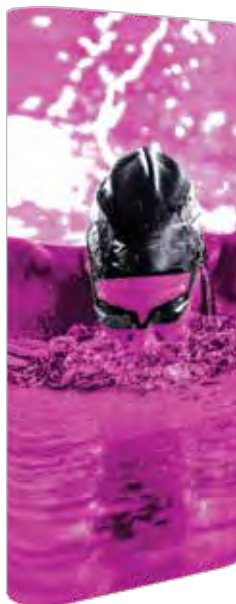
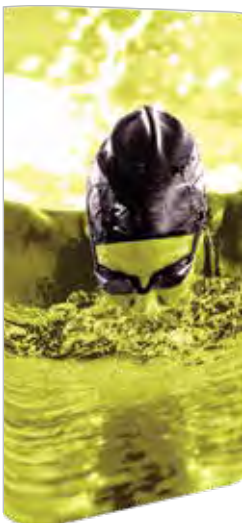

LED light strips attach with clamps



easy-to-apply pillowcase fabric graphics

FORMULATE ESSENTIAL BACKLIT

- standard height = 78.75"
- height with extension kit = 93.5"
- standard depth = 12.5"
- straight aluminum tube frame
- rounded corners
- bungee cords for easy assembly
- LED light strips attach with clamps to top and bottom horizontal bars
- double-sided pillowcase fabric graphic
- comes with carry bag

code	width	assembled dimensions
FMLT-E-BL-1100	50.75"	⊗ 43.25"w x 78.75" - 93.5"h x 12.5"d

Fabric Banners & Backwalls



Illuminate and draw attention!

FORMULATE MASTER BACKLIT BACKWALLS

- offered in 3', 5' & 8' widths, all 8'h
- tube frames feature spigot assembly
- LED light curtains attach to the frame
- pillowcase fabric graphic slips over frame
- ships in OCE-2 case

name	code	assembled dimensions
3' Backlit kit	FMLT-BL-WS3-01	Ⓞ 34.69" w x 92" h x 25.59" d
5' Backlit kit	FMLT-BL-WS5-01	Ⓞ 61.75" w x 92" h x 26.63" d
8' Backlit kit	FMLT-BL-WS8-01	Ⓞ 90" w x 92" h x 26.63" d

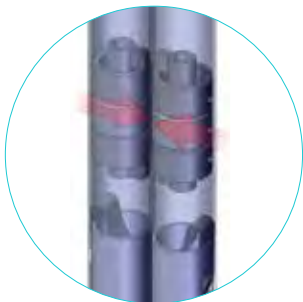

magnetized connection

high-powered internal magnets for connection of frames

MODULATE MAGNETIC MIX & MATCH BANNERS

- toolless assembly
- magnetic frames allow for customized configurations of banners & backwalls
- aluminum tube frames connect with snap buttons and all units come with easy-to-use twist-lock feet
- pillowcase fabric graphics slip over frame

size/name	code	assembled dimensions
Banner 1	MOD-FRM-01-M-TL	Ⓞ 60" w x 96" h x 19" d
Banner 2	MOD-FRM-02-M-TL	Ⓞ 60" w x 96" h x 19.3" d
Banner 3	MOD-FRM-03-M-TL	Ⓞ 35" w x 96" h x 17.72" d
Banner 4	MOD-FRM-04-M-TL	Ⓞ 35" w x 96" h x 17.72" d
Banner 5	MOD-FRM-05-M-TL	Ⓞ 112.58" w x 92.36" h x 31.23" d
Banner 6	MOD-FRM-06-M-TL	Ⓞ 45.74" w x 96" h x 17.72" d
Banner 7	MOD-FRM-07-M-TL	Ⓞ 90.78" w x 92" h x 17.72" d
Banner 8	MOD-FRM-08-M-TL	Ⓞ 46.7" w x 92" h x 17.72" d
Banner 9	MOD-FRM-09-M-TL	Ⓞ 66.74" w x 96" h x 17.72" d
Banner 10	MOD-FRM-10-M-TL	Ⓞ 32.74" w x 96" h x 17.72" d
Banner 11	MOD-FRM-11-M-TL	Ⓞ 43.74" w x 92" h x 17.72" d
Banner 12	MOD-FRM-12-M-TL	Ⓞ 96.34" w x 48.39" h x 17.72" d
Banner 13	MOD-FRM-13-M-TL	Ⓞ 48.74" w x 96" h x 17.72" d
Banner 14	MOD-FRM-14-M-TL	Ⓞ 96.7" w x 96" h x 17.7" d



Eye-catching Light Boxes

VECTOR FRAME ESSENTIAL LIGHT BOXES

These sophisticated light boxes have superior aesthetic and assembly qualities and require no tools for assembly! Simply slide each frame piece together, apply the push-fit fabric graphics and plug in. LED lighting comes pre-attached to the frame and swivel lock feet give added stability. These displays are ideal for retail, interior and event environments.

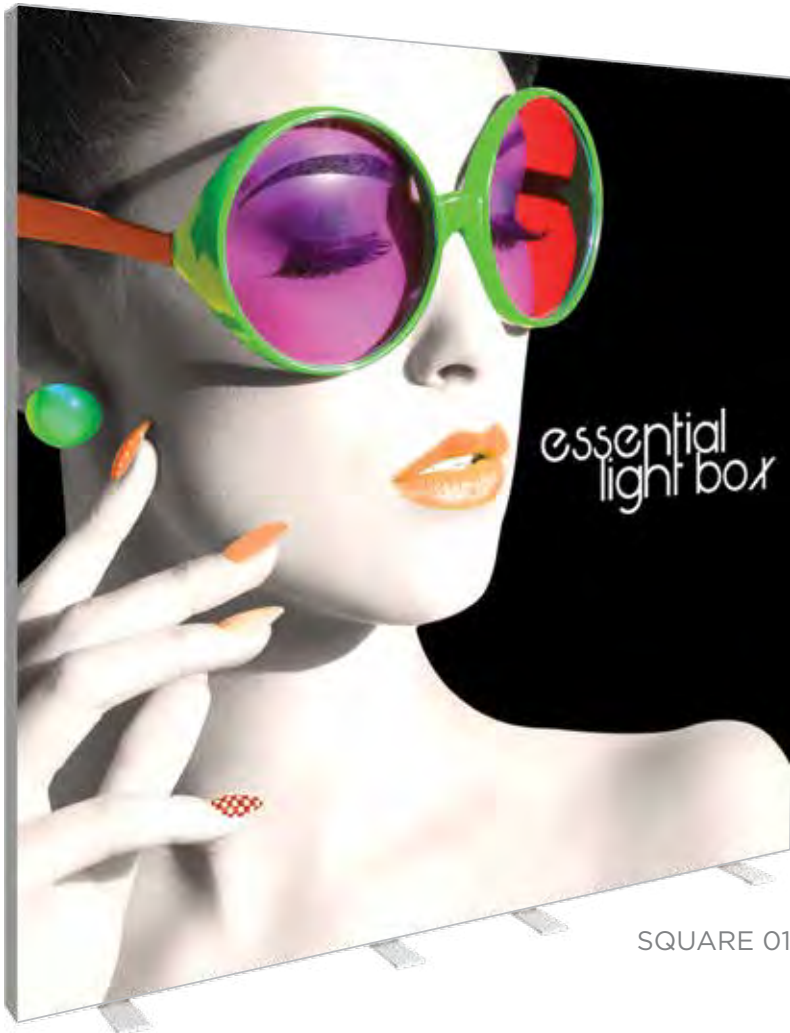

frame easily assembles

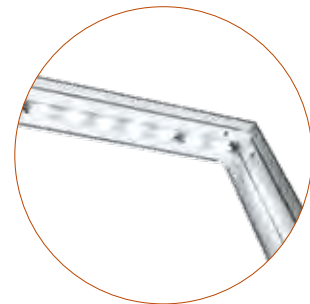

lights come pre-attached to the frame

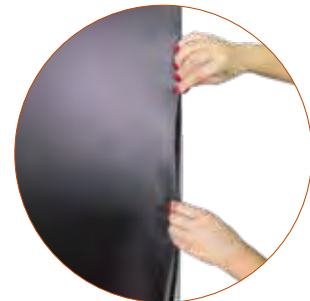

easy-to-apply push-fit graphics

Details

- light boxes feature sleek, scratch-resistant white aluminum frames with swivel feet
- LED light strips are pre-attached to the top and bottom of the frame
- includes choice of single or double-sided push-fit INTENSITY backlit fabric graphic
- includes 6' power cord
- comes with reusable cardboard box with handle
- easy to assemble

Size Options

name	code	graphic width	graphic height	assembled dimensions
Rectangle 01	VF-ESS-LB-R-01	33.88"	71.88"	ⓐ 36" w x 72.75" h x 15.75" d
Rectangle 02	VF-ESS-LB-R-02	35.88"	95.88"	ⓐ 36" w x 96.75" h x 15.75" d
Rectangle 03	VF-ESS-LB-R-03	47.88"	71.88"	ⓐ 48" w x 72.75" h x 15.75" d
Rectangle 04	VF-ESS-LB-R-04	47.88"	95.88"	ⓐ 48" w x 96.75" h x 15.75" d
Square 01	VF-ESS-LB-S-01	95.88"	95.88"	ⓐ 96" w x 96.75" h x 15.75" d
Rectangle 05	VF-ESS-LB-R-05	119.88"	95.88"	ⓐ 120" w x 96.75" h x 15.75" d
Rectangle 06	VF-ESS-LB-R-06	244.13"	100.5"	ⓐ 240.5" w x 97" h x 15.75" d

perfect for retail stores, airports, restaurants and more!



Illuminating & Striking

VECTOR FRAME MASTER LIGHT BOXES & BANNERS

Details

- banners feature 2" aluminum extrusion frames and push-fit silicone-edge fabric graphics
- light boxes feature 4" aluminum extrusion frames with new & improved LED edge lighting & push-fit INTENSITY backlit fabric graphics
- single and double-sided graphics offered
- come in OCE, OCS, OCH or OCL hard shipping cases

Size Options

name	code	graphic width	graphic height	assembled dimensions
Rectangle 01	VF-R-01 VF-LB-R-01	35.31"	47.125"	ⓐ 36.3"w x 47.49"h x 19.69"d
Rectangle 02	VF-R-02 VF-LB-R-02	35.31"	70.75"	ⓐ 36.3"w x 71.12"h x 19.69"d
Rectangle 03	VF-R-03 VF-LB-R-03	47.125"	70.75"	ⓐ 48.11"w x 71.12"h x 19.69"d
Rectangle 04	VF-R-04 VF-LB-R-04	47.125"	94.375"	ⓐ 48.11"w x 94.74"h x 19.69"d
Rectangle 05	VF-R-05 VF-LB-R-05	118"	94.375"	ⓐ 118.98"w x 94.74"h x 19.69"d
Rectangle 06	VF-R-06 VF-LB-R-06	35.68"	94.38"	ⓐ 35.7"w x 94.74"h x 19.69"d
Rectangle 07	VF-R-07 VF-LB-R-07	236.13"	94.38"	ⓐ 236.5"w x 94.74"h x 19.69"d
Rectangle 08	VF-R-08 VF-LB-R-08	355.19"	94.38"	ⓐ 355.19"w x 94.74"h x 19.69"d
Square 01	VF-S-01 VF-LB-S-01	35.31"	35.31"	ⓐ 36.3"w x 35.68"h x 19.69"d
Square 02	VF-S-02 VF-LB-S-02	47.125"	47.125"	ⓐ 48.11"w x 47.49"h x 19.69"d
Square 03	VF-S-03 VF-LB-S-03	70.75"	70.75"	ⓐ 71.73"w x 71.12"h x 19.69"d
Square 04	VF-S-04 VF-LB-S-04	94.375"	94.375"	ⓐ 95.35"w x 94.74"h x 19.69"d

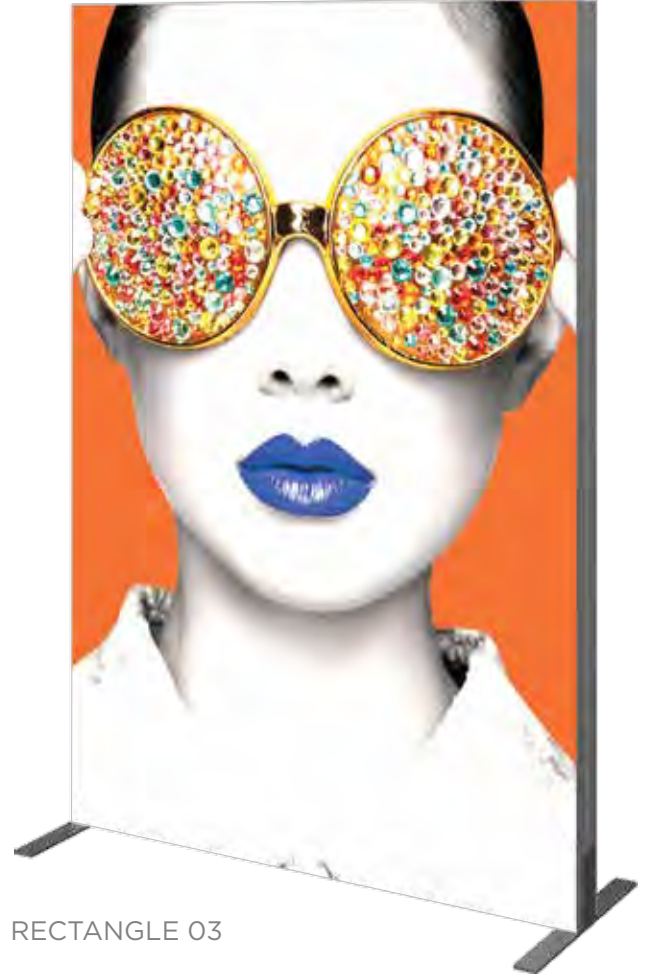

RECTANGLE 03

CURVED BANNERS



*Use as a
concave or
convex shape!*



01 Curved Rectangle
VF-CR-01
39.33"w x 94.74"h x 19.69"d

02 Curved Rectangle
VF-CR-02
56.75"w x 94.74"h x 19.49"d

03 Curved Rectangle
VF-CR-03
67.99"w x 94.74"h x 18.75"d





HANGING BANNERS

indoor and outdoor

Captivating & Durable

Hanging banners are ideal for promoting events, advertising or branding in any indoor or outdoor environment. Banners are available in custom sizes ranging from minimum 2' wide/high to maximum 10' wide/high. Choose from several finishing options described below.

indoor banners



13 OZ. VINYL SINGLE-SIDED

Durable and lightweight



FABRIC SINGLE-SIDED

Choice of Display Poly or Oxford fabric

outdoor banners

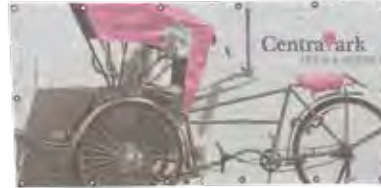

8 OZ. MESH VINYL SINGLE-SIDED

Banners allow wind to stream through for durability.



13 OZ. SCRIM VINYL SINGLE-SIDED & 18 OZ. SCRIM VINYL SINGLE & DOUBLE-SIDED

Durable and weather-resistant, scrim hanging banners are ideal for long-term outdoor use.

Offered in a wide selection of sizes, materials and styles to fit your advertising needs!



6.5 OZ. OUTDOOR CANVAS SINGLE-SIDED

Water and UV resistant

INDOOR FINISHING STYLES



no finishing (vinyl)



hem only (fabric)



hem & #3 grommet



rope & #3 grommet



3" pole pocket

OUTDOOR FINISHING STYLES



no finishing (scrim)



hem only (canvas)



hem & #3 grommet



rope & #3 grommet



3" pole pocket

Wall Mounted Poster Frames

Trappa Snap frames snap open from the front to allow quick and easy graphic changes. No tools are required. Comes standard with clear protective lenses, fully assembled and ready to hang.

TRAPPA™ POSTER FRAME



- black or silver anodized finish with precision mitered corners
- spring loaded aluminum extrusions mounted to a high-impact polystyrene backer
- Trappa Frame edges snap open from the front to allow quick and easy graphic changes with no tools required
- available in a wide range of standard sizes & includes a clear anti-glare lens
- custom sizes also offered

code	insert size	assembled dimensions
TRP2-1-S/B	8.5" w x 11" h	Ⓞ 9.75" w x 12.25" h
TRP2-2-S/B	11" w x 14" h	Ⓞ 12.25" w x 15.25" h
TRP2-11-S/B	11" w x 17" h	Ⓞ 12.25" w x 18.25" h
TRP2-12-S/B	12" w x 18" h	Ⓞ 13.25" w x 19.25" h
TRP2-4-S/B	16" w x 20" h	Ⓞ 17.25" w x 21.25" h
TRP2-5-S/B	20" w x 24" h	Ⓞ 21.25" w x 25.25" h

code	insert size	assembled dimensions
TRP2-6-S/B	24" w x 36" h	Ⓞ 25.25" w x 37.25" h
TRP2-7-S/B	22" w x 28" h	Ⓞ 23.25" w x 29.25" h
TRP2-8-S/B	24" w x 30" h	Ⓞ 25.25" w x 31.25" h
TRP2-9-S/B	30" w x 40" h	Ⓞ 31.25" w x 41.25" h
TRP2-10-S/B	18" w x 24" h	Ⓞ 19.25" w x 25.25" h

POSTER SNAPPER



- adjustable hanging clips slide along the top rail to match desired spacing
- hanging clips feature both top opening for clear nylon line mount, and recessed pocket for S-hook suspension
- rails snap open and shut for quick graphic changes
- clean, simple, elegant look
- comes in 4 different standard widths: 24", 30", 36", 48"
- custom cut width available up to 60"



TRAPPA LIGHT BOX



- only 1" thick (single-sided only)
- 50,000 hour bulb life
- evenly distributed light via LED diffuser panel
- snap frames allow easy graphic changes
- wall mounting hardware
- power supply with 78" cord
- must ship freight

name	width	height	code	assembled dimensions
Light box 03	24"	36"	LED-SNAP-03-2	Ⓞ 25.75" w x 37.75" h x 1.1" d
Light box 04	30"	40"	LED-SNAP-04-2	Ⓞ 31.75" w x 41.75" h x 1.1" d
Light box 05	36"	48"	LED-SNAP-05-2	Ⓞ 37.75" w x 49.75" h x 1.1" d

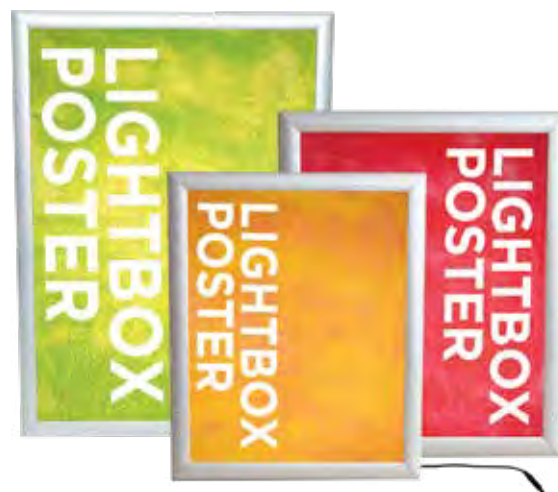

Wall Mounted Poster Frames

Vector Frame™ Edge fabric poster displays combine durable, slim 3/4" lightweight aluminum extrusion frames and easy-to-apply push-fit fabric graphics. Custom frame sizes are available.

VECTOR FRAME™ EDGE

Details

- slim, lightweight 3/4" aluminum frame
- easy-to-apply push-fit fabric graphic
- direct to wall mounting
- custom frame sizes available

Size Options

name	code	assembled dimensions
Square 01	VFE-S-01	Ⓞ 11.8" w x 11.8" h x .79" d
Square 02	VFE-S-02	Ⓞ 26.3" w x 26.3" h x .79" d
Square 03	VFE-S-03	Ⓞ 35.43" w x 35.43" h x .79" d
Square 04	VFE-S-04	Ⓞ 47.24" w x 47.24" h x .79" d
Square 05	VFE-S-05	Ⓞ 59.06" w x 59.06" h x .79" d
Rectangle 01	VFE-R-01	Ⓞ 11.8" w x 23.62" h x .79" d
Rectangle 02	VFE-R-02	Ⓞ 11.8" w x 35.43" h x .79" d
Rectangle 03	VFE-R-03	Ⓞ 23.62" w x 35.43" h x .79" d
Rectangle 04	VFE-R-04	Ⓞ 23.62" w x 47.24" h x .79" d



lightweight extrusion frame and easy-to-apply push-fit fabric graphics!



*Use for ads in retail settings
or any type of interior!*

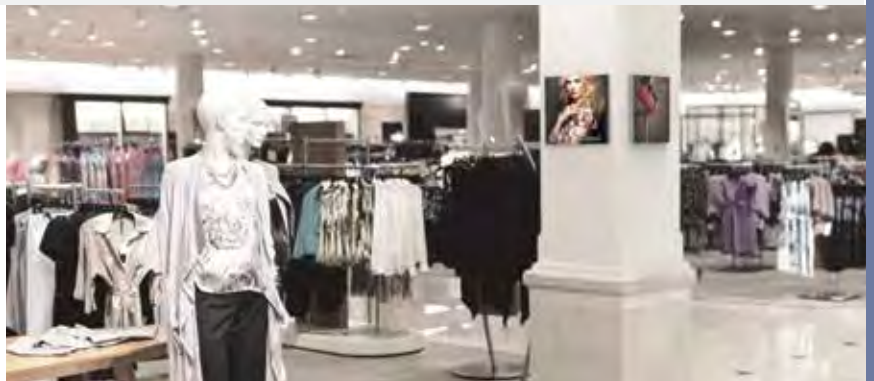



OUTDOOR

displays

Promote & Capture Attention

Outdoor events such as festivals, street fairs, arts and craft shows and sporting events are perfect opportunities for promotional tents and signage to clearly display your company name, brand and message to attract visitors and buyers. Choose from off-the-shelf tents and related accessories, flags and portable billboards to make your event a success.



Attract and engage visitors at any outdoor event!

Zoom™ Popup Tents



10' ECONOMY (STEEL)

- black powder-coated economy frame with square leg
- opens to a base size of 9.8' x 9.8'
- hardware only kit includes frame, stakes, guy lines and rolling carry bag
- canopy kits include canopy (standard colors or custom printed), hardware frame, stakes, guy lines and rolling carry bag

name	code
Hardware only kit	TNT-E-3X3-SQ-3
Kit with canopy	TNT-E-3X3-SQ-2-G
Stock canopy only	ZM-TNT-3MX3M-CAN-(COLOR)
Printed canopy only	TNT-3X3-CAN-G
Full wall kit	TNT-3X3-FWL-G - sold separately
Half wall kit	TNT-3X3-HLF-K-G - sold separately



10' STANDARD (ALUMINUM)

- rust-resistant silver aluminum frame with hex leg
- opens to a base size of 9.8' x 9.8'
- hardware only kit includes frame, stakes, guy lines and rolling carry bag
- canopy kits include canopy (standard colors or custom printed), hardware frame, stakes, guy lines and rolling carry bag

name	code
Hardware only kit	TNT-S-3X3-HEX-FRM
Kit with canopy	TNT-S-3X3-HEX-G
Stock canopy only	ZM-TNT-3MX3M-CAN-(COLOR)
Printed canopy only	TNT-3X3-CAN-G
Full wall kit	TNT-3X3-FWL-G - sold separately
Half wall kit	TNT-3X3-HLF-K-G - sold separately

Canopies, half and full walls are water-resistant!

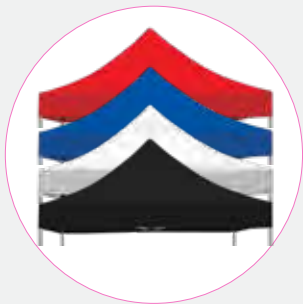

all 10' & 20' tents available fully printed & with stock canopy tops and walls



Zoom™ Light Kit attaches to 5', 10' & 20' Economy tents with magnets and Standard tents with hook & loop - see p. 152 for more details



10' & 20'w tents come in roller bag

Zoom™ Popup Tents



20' STANDARD (ALUMINUM)

- 20' opens to a base size of 9.8' x 19.6'
- rust-resistant, lightweight aluminum frame is completely self-contained with no loose parts
- hex leg

name	code
Hardware only kit	TNT-S-3X6-HEX
Kit with canopy	TNT-S-3X6-HEX-G
Stock canopy only	ZM-TNT-3MX6M-CAN-(COLOR)-3
Printed canopy only	ZM-TNT-3MX6M-CAN-G
Full wall kit	TNT-S-3X6-FWL-G
Half wall kit	TNT-S-3X6-HWL-K-G



5' ECONOMY (STEEL)

- opens to a base size of 4.7' x 4.7'
- black powder coated economy steel tent frame is completely self-contained with no loose parts
- square leg
- custom printed canopy is water and UV-resistant
- hardware kit includes frame, stakes, guy lines and rolling carry bag
- canopy kits include custom printed canopy, hardware frame, guy lines and rolling carry bag

name	code
Hardware only kit	TNT-E-1.5-FRM-SQ-3
Kit with canopy	TNT-E-1.5-SQ-2-G
Printed canopy only	TNT-1.5-CAN-G
Full wall kit	TNT-1.5-FWL-G

Accessorize



STOCK HALF & FULL WALLS

- compatible with both Zoom™ Standard and Economy tent frames
- half wall kit includes half wall panel (stock or custom print), half wall pole and two brackets (10' & 20' tents only)
- full wall kits include full wall panel (stock or custom print)
- canvas cannot be printed on; panels are water and UV resistant

four stock colors to choose from!



optional flag accessory attaches to any upright pole of any Zoom Popup Tent



Outdoor Tents & Displays



ZOOM™ FLEX TENT



- opens to a size of 8.6' x 8.6'
- comes with fiberglass poles, ground stakes and canopy
- custom printed canopy is mesh fabric
- withstands winds up to 15 mph
- add stackable bases for extra stability
- includes carry bag

name	code	assembled dimensions
flex tent	ZOOM-FLX-TNT	📏 103" w x 112" h x 103" d



Top view



CAMPAIGN



- hook & loop PVC graphic
- quick assembly
- strong & easy-to-clean plastic parts

code	assembled dimensions
CP-B3	📏 counter: 32" w x 34.5" h x 18.5" d entire unit: 32.68" w x 80.71" h x 19.29" d

Plastic construction makes Campaign easy to clean!

Popup Bar™ Collapsible Counter

The portable Popup Bar™ is an expandable, wheeled sampling and serving station perfect for any event—indoor or outdoor! The pre-assembled aluminum frame comes together by unfolding the legs and inserting the interior shelf panels. Fully-customized fabric graphics on the front and sides will win visitors over as you provide an effortless serving experience.



pre-assembled frame pops up with ease

Simple assembly!



zipper enclosed storage space



use as a cart



add an accessory header to mini and large



Details

- portable, pre-assembled aluminum frame
- zipper-enclosed storage space
- printable graphics on sides & front, attached by hook and loop
- locking wheel casters
- kit includes frame, graphics, two shelves and carry bag
- optional accessory headers that attach to the top of the mini & large Popup bars
- graphic header measure 16" graphic height

Size Options

size	code	assembled dimensions
popup bar mini	PBFM902-B	Ⓞ 23.94" w x 36.63" h x 20" d
popup bar large	PBFL301-B	Ⓞ 40.13" w x 36.5" h x 20.06" d
popup bar mini header	PBFM902-B-HDR	Ⓞ 22.13" w x 59.52" h x 1.18" d
popup bar large header	PBFL301-B-HDR	Ⓞ 38.233" w x 59.52" h x 1.18" d



Zoom™ Flex Flags

Details

- can be used indoors or outdoors
- comes in four shapes: teardrop, feather, straight & edge
- graphic rotates in wind
- water ring base support adds stability to cross base (optional upgrades)
- graphic printed on flag material
- double-sided graphic available
- includes ground stake; various base options available

size	hardware code	assembled dimensions
small flag - teardrop, feather, straight	ZOOM-FLX-SM	⊗ 46" - 64"w x 84.13" - 113.13"h x 1.75"d
medium flag - teardrop, feather, straight	ZOOM-FLX-M	⊗ 46" - 64"w x 116.13" - 138.63"h x 1.75"d
large flag - teardrop, feather, straight	ZOOM-FLX-LG	⊗ 46" - 64"w x 160.13" - 178.38"h x 1.75"d
extra large flag - feather, straight	ZOOM-FLX-XL-2	⊗ 34.63"w x 222.5"h x 1.75"d
small flag - edge	ZOOM-FLX-SM-E	⊗ 46" - 64"w x 84.13" - 113.13"h x 1.75"d
medium flag - edge	ZOOM-FLX-M-E	⊗ 46" - 64"w x 116.13" - 138.63"h x 1.75"d
large flag - edge	ZOOM-FLX-LG-E	⊗ 46" - 64"w x 160.13" - 178.38"h x 1.75"d
extra large flag - edge	ZOOM-FLX-XL-E	⊗ 34.63"w x 222.5"h x 1.75"d



shown with optional cross base & water ring base support

small medium large extra large

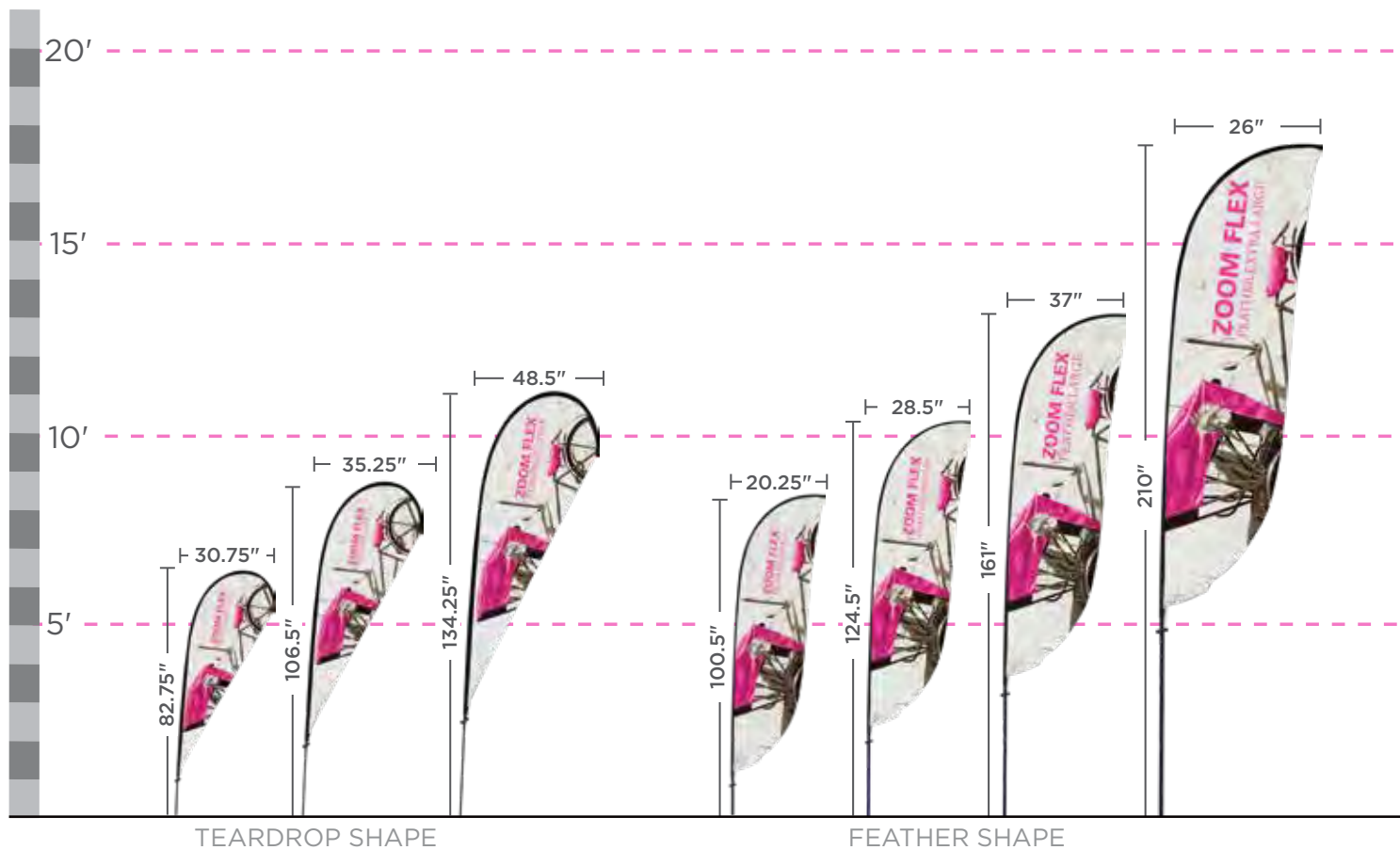

Zoom™ Flex Flags

ZOOM™ BASE OPTIONS

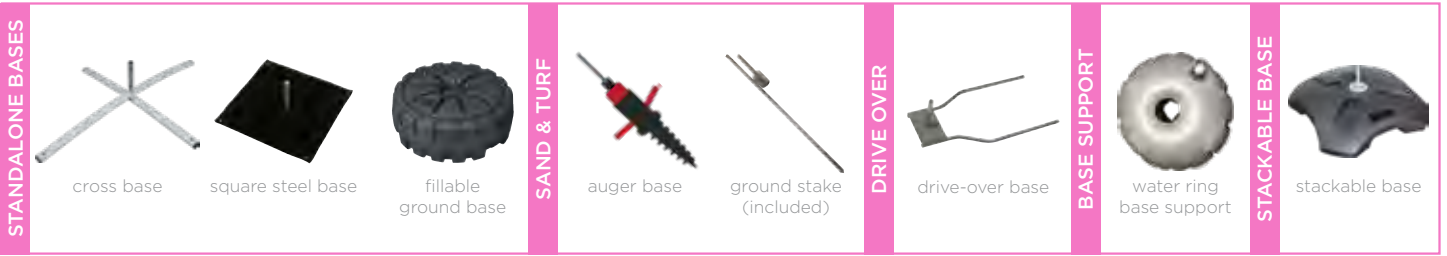

name	code	assembled dimensions
cross base	ZM-FLX-CB	⊘ 31" w x 6.75" h x 24" d
square steel base	ZM-FLX-SQ	⊘ 17.75" w x 5" h x 17.75" d
fillable ground base	ZM-FLX-FB	⊘ 19.7" w x 10.25" h x 19.7" d
auger base	ZM-FLX-AGR	⊘ 8.88" w x 21.75" h x 3.75" d
ground stake (included)	ZM-FLX-STK	⊘ 23.75" w x 1.75" h x 1.25" d
drive-over base	ZM-FLX-DO	⊘ 23.62" w x 5.71" h x 7.87" d
water ring base support	ZM-FLX-WR	⊘ 20.28" w x 5" h x 20.28" d
stackable base	ZM-FLX-STCK-BASE	⊘ 25" w x 11" h x 25" d

not to exact scale, refer to graphic templates

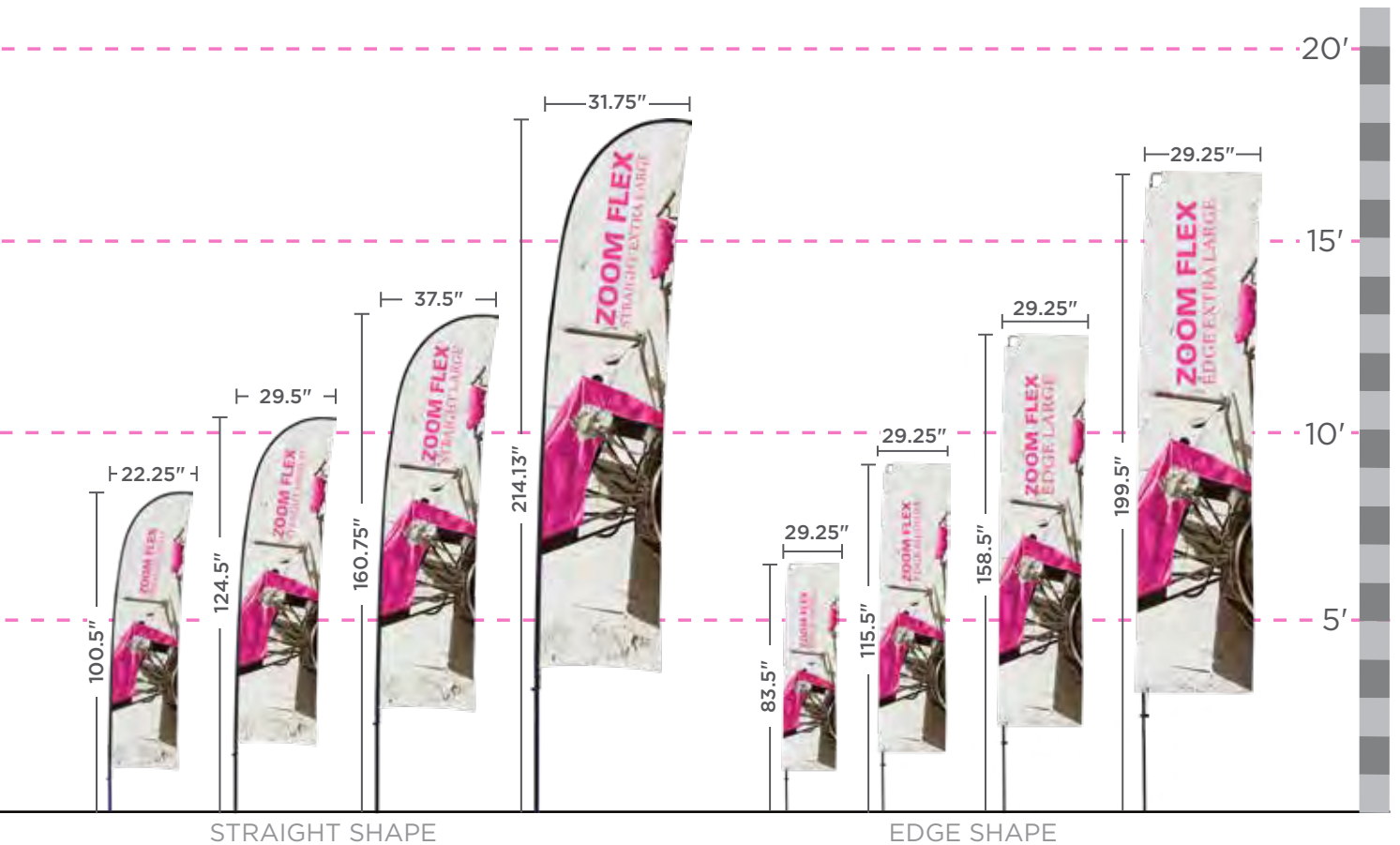

Outdoor Signage

Great for outdoor sporting events and arenas, concerts, festivals and more. Outdoor display products are strong, solid, stable, wind-resistant and durable. Graphics are long-lasting and can endure exposure to outdoor elements.



WIND DANCER MINI



- adjustable graphic height = up to 6'
- approximate max height = 8.3'
- economy outdoor flag
- plastic pole, easy push-fit assembly
- hollow plastic base can be filled with water or sand
- double-sided graphic available

name	code	assembled dimensions
wind dancer mini	WIND-MIN	Ⓞ 16.31" w x 56" h - 100.32" h x 16.31" d



WIND DANCER LT

- adjustable graphic height = up to 8'8"
- approximate max height = 13.5'
- hollow plastic base can be filled with water or sand
- double-sided graphic available
- optional carry bag

name	code	assembled dimensions
wind dancer lt	WIND-LT	Ⓞ 36" w x 116" h - 162" h x 25.5" d



WIND DANCER

- adjustable graphic height = up to 12'
- approximate max height = 17.5'
- flag is approximately 43" wide
- hollow plastic base can be filled with water or sand
- double-sided graphic available
- optional carry bag

name	code	assembled dimensions
wind dancer	WIND-MX	Ⓞ 36" w x 209" h x 36" d



SWING SIGN

- visual graphic area = 19.63" w x 29.5" h
- single or double-sided graphic, printed on 6mm PVC
- black, steel portable sign with integrated wheeled base
- hollow plastic base can be filled with sand or water
- double-ring mounting system holds graphic in place while allowing it to swing

name	code	assembled dimensions
swing sign	SWING-SIGN	Ⓞ 24.5" w x 39" h x 15.75" d



WHIRLWIND

- front-loading snap frames constructed from aluminum & powder-coated steel
- single or double-sided
- includes clear lens cover
- dual-spring design flexes to withstand wind gusts
- compact durable base can be filled with water or sand for extra stability
- integrated wheel set

name	code	assembled dimensions
whirlwind	WHRL-WND-2	Ⓞ 30.75" w x 44.12" h x 19.5" d



BARRICADE COVERS

- double-sided barricade covers, offered in two widths, 6ft and 8ft
- offered in your choice of Power Stretch Dye-sublimated fabric or UV printed Outdoor Canvas
- can be used indoors and outdoors
- cover only; barricade hardware not included
- cover includes two, 2 x 2 notches on one side, two zippers on the other side, open bottom

size	code	assembled dimensions
72" w x 36" h	C-BRC-72X36-PS-G-W C-BRC-72X36-OD-GDBL	Ⓞ 72" w x 36" h x 0.5" d
97" w x 36" h	C-BRC-97X36-PS-G-W C-BRC-97X36-OD-GDBL	Ⓞ 97" w x 36" h x 0.5" d



Outdoor Signage



ARROW UP



ARROW SIDE



WAVE 1



BOTTLE



CIRCLE



WAVE 2

CONTOUR

- two printed graphics (front & back) available in six unique shapes
- choose from plate base or hollow, fillable base with dual-spring design to flex and withstand wind gusts
- hollow, fillable base can be filled with water or sand for added stability
- graphics easily secure to either base using hook & loop

base options

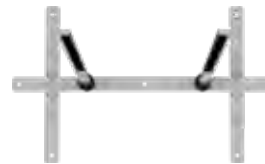

Plate Base



Fillable Base

name	code	assembled dimensions
arrow up	CONTOUR-01-G	Ⓞ 34.75" w x 70" h x 18.75" d
arrow side	CONTOUR-02-G	Ⓞ 45.88" w x 38.25" h x 23.62" d
wave 1	CONTOUR-03-G	Ⓞ 30.38" w x 80.5" h x 18.75" d
bottle	CONTOUR-04-G	Ⓞ 39.37" w x 75" h x 23.62" d
circle	CONTOUR-05-G	Ⓞ 37" w x 48.5" h x 18.75" d
wave 2	CONTOUR-06-G	Ⓞ 39.37" w x 65" h x 23.62" d

Choose your sign and base shape!



APEX

- double-sided plastic A-frame
- printed directly on the plastic for a smooth look
- for indoor or outdoor use

name	code	assembled dimensions
apex	APEX	Ⓞ 31" w x 6.75" h x 24" d



ACE-2

- visual graphic area = 28.87" w x 35" h
- double-sided aluminum A-frame sign holder with black plastic corner grips
- clear dry erase graphic lenses included
- front-loading snap frames for easy graphic swaps
- quick, toolless assembly

name	code	assembled dimensions
ace-2	ACE-2	Ⓞ 31" w x 6.75" h x 24" d



ACE ECO

- foldable, economy aluminum A-frame sign
- choice of printed 6mm PVC boards and/or dry erase boards
- boards slide in at the top of the frame
- can be used indoors and outdoors
- quick, toolless assembly

name	code	assembled dimensions
ace eco	ACE-ECO	Ⓞ 31" w x 6.75" h x 24" d



Outdoor Signage

Outdoor display products are strong, solid, stable, wind-resistant and durable. Graphics are long-lasting and can endure exposure to outdoor elements.

THUNDER



- double-sided outdoor retractable banner stand
- large twist-lock feet
- stakes included to secure to ground
- snap-top graphic rail
- 3-piece bungee pole

code	assembled dimensions
THUNDER-1	35.06" w x 82.75" h x 29" d

BLIZZARD



- max width x min height: 40" w x 57" h
- min width x max height: 23.5" w x 80" h
- max width x max height: 40" w x 74.5" h
- min width x min height: 23.5" w x 63.25" h
- hollow base can be filled with either water or sand as weighing agent
- easy grommet graphic attachment

code	assembled dimensions
BLZD	23.5" - 48" w x 63.25" - 74" h

MONSOON



- visual graphic area = approx. 92.125" w x 32" h
- semi-portable single or double-sided billboard
- easy grommet graphic attachment
- includes ground stakes & bungee rope
- comes with carry case

code	assembled dimensions
MONSN-2	98.43" w x 37.99" h x 25.2" d

STOWAWAY



- lightweight, high visual-impact display stand
- indoor/outdoor use
- carbon fiber bungee poles easily assemble
- includes ground stakes and carry case
- no tools required
- custom printed graphics

code	assembled dimensions
STOW-3-S	75.5" w x 37" h x 24" d
STOW-3-L	97.5" w x 50" h x 34" d
STOW-3-XL	134" w x 63" h x 43" d



Outdoor Signage

ZOOM™ FLEX OUTDOOR BILLBOARD



- heavy-duty tubular frame with flexible fiberglass poles at the top
- single or double-sided mesh pillowcase fabric graphic slips over frame (no base or bag, packs in box)
- includes two bags to add weight for stability

code	assembled dimensions
ZOOM-FLX-OD-BB	Ⓞ 106" w x 78.74" h x 32" d

ZOOM™ FLEX ARCH



*add stackable bases
for extra stability!*

- perfect for outdoor races, cross country events, finish lines
- arch shaped flexible fiber poles hold flag graphic
- stakes included
- add sturdy sand or water fillable bases for more stability

code	assembled dimensions
ZOOM-FLX-ARCH	Ⓞ 114" w x 113.85" h x 1.75" d

TWIRL



top view

- lightweight, fiberglass rod frame
- double-sided pillowcase fabric graphic
- ground stake connection allows for twirl movement

name	code	assembled dimensions
twirl	TWIRL	Ⓞ 26.41" w x 79" h x 1" d

PARKWAY



- withstands winds up to 38MPH
- single or double span street pole banner

code	assembled dimensions
PKWY-S-SPN-3	Ⓞ single span: 32" w x 60" h
PKWY-D-SPN-3	Ⓞ double span: 67" w x 60" h



Table Throws & Runners

FULLY PRINTED TABLE THROW

- complete your presentation with a 4', 6' or 8' full or economy premium printed table throw
- lends a polished appearance to any display
- maximize your advertising with additional space to display your message

size	code	assembled dimensions
4' full	TBL-T-4-F	Ⓞ 48" w x 30" h x 24" d
4' economy	TBL-T-4-E	Ⓞ 48" w x 30" h x 24" d
4' full (48" w x 36" h)	TBL-T-4-36-F	Ⓞ 48" w x 36" h x 24" d
6' full	TBL-T-6-F	Ⓞ 72" w x 30" h x 30" d
6' economy	TBL-T-6-E	Ⓞ 72" w x 30" h x 30" d
8' full	TBL-T-8-F	Ⓞ 96" w x 30" h x 30" d
8' economy	TBL-T-8-E	Ⓞ 96" w x 30" h x 30" d



Economy table throws have a shortened back.



CONVERTIBLE TABLE THROW

- printed throw converts quickly and easily to fit both a 6' and 8' table
- hook and loop tabs make conversion simple

size	code	assembled dimensions
full - fits 6' & 8' table	TBL-T-FC	Ⓞ 70" - 96" w x 30" h x 30" d
economy - fits 6' & 8' table	TBL-T-EC	Ⓞ 70" - 96" w x 30" h x 30" d



TABLE RUNNERS

- accent your solid colored table throw with a full color printed runner
- available in four widths

size	code	assembled dimensions
24" full	TBL-R-24-F	Ⓞ 24" w x 84" h
24" economy	TBL-R-24-E	Ⓞ 24" w x 62.75" h
30" full	TBL-R-30-F	Ⓞ 30" w x 84" h
30" economy	TBL-R-30-E	Ⓞ 30" w x 62.75" h
36" full	TBL-R-36-F	Ⓞ 36" w x 84" h
36" economy	TBL-R-36-E	Ⓞ 36" w x 62.75" h
60" full	TBL-R-60-F	Ⓞ 60" w x 84" h
60" economy	TBL-R-60-E	Ⓞ 60" w x 62.75" h

Fully printed, excellent quality!



Table Throws & Runners

STRETCH TABLE THROW



- tailored to fit 4', 6' & 8' tables top to bottom
- optional carry bag available, see p. 36
- stretch fabric dye-sublimated printed table throw lends a stylish look to any display
- zipper in the back provides access to underneath the table

size	code	assembled dimensions
4' full	TBL-SW-4-F	Ⓞ 48" w x 30" h x 24" d
4' full (48" w x 36" h)	TBL-SW-4-36-F	Ⓞ 48" w x 36" h x 24" d
6' full	TBL-SW-6-F	Ⓞ 72" w x 30" h x 30" d
8' full	TBL-SW-8-F	Ⓞ 96" w x 30" h x 30" d

FITTED TABLE THROW



- form fitted to fit 4', 6' & 8' tabletops
- optional carry bag available, see p. 36
- fitted fabric dye-sublimated printed table throw lends a polished look to any display

size	code	assembled dimensions
4' full	TBL-FITTED-4-F	Ⓞ 48" w x 30" h x 24" d
4' full (48" w x 36" h)	TBL-FITTED-4-36-F	Ⓞ 48" w x 36" h x 24" d
4' economy	TBL-FITTED-4-36-E	Ⓞ 48" w x 30" h x 24" d
6' full	TBL-FITTED-6-F	Ⓞ 72" w x 30" h x 30" d
8' full	TBL-FITTED-8-F	Ⓞ 96" w x 30" h x 30" d



ROUND TABLE THROWS

- tailored to fit round tables
- printed on premium dye-sublimated fabric
- all options lend a stylish and polished look to any event

size	code	assembled dimensions
30" dia., 30" h - draped, fitted & stretch	RND-TBL-T-30X30 RND-TBL-FT-30X30 RND-TBL-SW-30X30	Ⓞ Draped: 16" w x 24" d Fitted, Top: 26" w x 26" d, Front: 16" w x 26" d Stretch, Top: 26" w x 26" d, Front: 9" w x 20" d
30" dia., 42" h - draped, fitted & stretch	RND-TBL-T-30X42 RND-TBL-FT-30X42 RND-TBL-SW-30X42	Ⓞ Draped: 16" w x 36" d Fitted, Top: 26" w x 26" d, Front: 16" w x 36" d Stretch, Top: 26" w x 26" d, Front: 9" w x 20" d
48" dia., 30" h - draped, fitted & stretch	RND-TBL-T-48X30 RND-TBL-FT-48X30	Ⓞ Draped: 20" w x 24" d Fitted, Top: 44" w x 44" d, Front: 20" w x 26" d
60" dia., 30" h - draped, fitted & stretch	RND-TBL-T-60X30 RND-TBL-FT-60X30	Ⓞ Draped: 30" w x 24" d Fitted, Top: 56" w x 56" d, Front: 30" w x 26" d



Water and spill resistant!



OUTDOOR TABLE THROW

- form fitted to fit 6' & 8' tabletops
- UV printed on outdoor canvas; remains on the table even in windy conditions
- water and spill resistant
- lends a polished look to any outdoor event or display

size	code	assembled dimensions
6' full	TBL-ODC-FITTED-6-F	Ⓞ 72" w x 30" h x 30" d
8' full	TBL-ODC-FITTED-8-F	Ⓞ 96" w x 30" h x 30" d



Folding Panel Tabletop Displays

Having a small space does not mean you cannot make a big impact! Tabletop displays are lightweight, highly portable and ideal for adding “WOW” factor to any 4’, 6’ or 8’ long standard table display.

HORIZON™ TABLETOP DISPLAYS

- main panel sizes approximately = 23.5" w x 35.5" h
- custom sized panel displays are available
- shown with optional detachable graphics
- available in a variety of fabric color options shown below



WEIGHS 12 LBS
Horizon 3
HZ-TT-S



WEIGHS 13.5 LBS
Horizon 5
HZ-TT-M



fabric choices

All folding panel display systems are available with printed graphic murals or “hook & loop-friendly” fabric panels of your choice. Actual fabric color may vary slightly.

REGAL - SMOOTH EXHIBIT & DISPLAY FABRIC

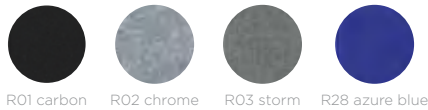

R01 carbon R02 chrome R03 storm R28 azure blue

PREMIER - RIBBED EXHIBIT & DISPLAY FABRIC



R28 persian blue R29 beach R31 eco green R30 maroon

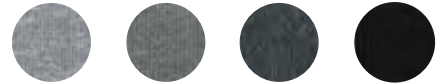

R02 steel R03 charcoal R15 cinder R01 lava

POPULAR TABLETOP DISPLAYS

Tabletop versions of the highly popular expandable Hopup™, Embrace™, Xclaim™ and Coyote™ fabric displays are available, providing numerous stylish options to choose from!



Hopup 5' Straight



Embrace 5' Straight



Xclaim 5' (Kit 02)



Coyote 6'

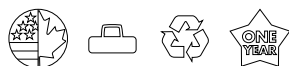

Tabletop Displays

VOYAGER™ FOLDING PANELS

The Voyager™ has been specially developed as a briefcase style tabletop display and is a great choice for promotions on the go. It has a rigid, thermo formed ABS exterior and a black, hook and loop friendly fabric interior. Detachable graphics allow for easy message changes! Headers shown are an additional option. Extra graphics can be stored in the display case and packed away for easy storage.



MINI KIT



MAXI KIT



MEGA KIT



SUPREME KIT



MONSTER KIT



size	code	assembled dimensions
mini kit (small, 5 lbs.)	VY-1	Ⓜ Open: 48" w x 18" h Closed: 24" w x 18" h
maxi kit (medium, 6.5 lbs.)	VY-2	Ⓜ Open: 48" w x 24" h Closed: 24" w x 24" h
mega kit (large, 8.25 lbs.)	VY-3	Ⓜ Open: 48" w x 32" h Closed: 24" w x 32" h
supreme kit (x-large, 8.25 lbs.)	VY-4	Ⓜ Open: 64" w x 24" h Closed: 32" w x 24" h
monster kit (xx-large, 10 lbs.)	VY-5	Ⓜ Open: 64" w x 32" h Closed: 32" w x 32" h

VOYAGER CARRY BAG



size	code
mini kit bag	VY-1-BG
maxi kit bag	VY-2-BG
mega kit bag	VY-3-BG
supreme kit bag	VY-4-BG
monster kit bag	VY-5-BG





YOUNG PROFESSIONAL
LEADERSHIP SEMINAR

HOPUP™

Tension fabric displays

Fast & Dynamic

The Hopup™ is one of the most dynamic and popular large format graphic displays due to its maximum impact with minimal effort. Hopup Tension Fabric Displays come in a variety of sizes and are offered in straight and curved frames with and without endcaps. Hopups require no tools for assembly, are lightweight and highly portable and they pack away as easy as they set up!

Two choices of frame shape

STRAIGHT OR CURVED

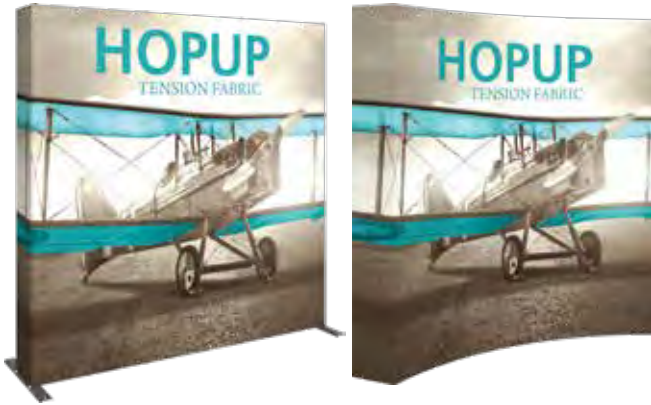

Two choices of graphic style

WITH OR WITHOUT ENDCAPS

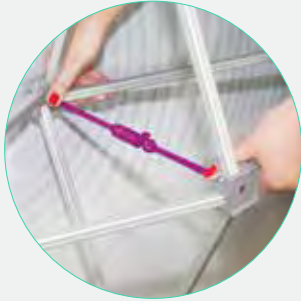

quickly & easily snap locking arms into place



hook & loop graphic is pre-attached on sizes 12ft & smaller, making setup simple



display pops up in minutes



carry bag included with most kits



add a counter - the perfect addition to any Hopup backwall display



optional upgrade - Lumina 200 light



Choose a size that's right for you!



TABLETOP



FLOOR BACKWALL



EXTRA LONG

Size Options

size	code	assembled dimensions
2 1/2' tabletop	HOP-1X1FG-S-1 HOP-1X1FGE-S-1	Ⓞ Straight: 31" w x 31" h x 12.25" d
5' tabletop	HOP-2X1FG-S/C-1 HOP-2X1FGE-S/C-1	Ⓞ Straight: 60.5" w x 31" h x 12.25" d Curved: 64" w x 31" h x 18" d
5' tabletop	HOP-2X2FG-S/C-1 HOP-2X2FGE-S/C-1	Ⓞ Straight: 60.5" w x 60.5" h x 12.25" d Curved: 64" w x 60.5" h x 18" d
7 1/2' tabletop	HOP-3X2FG-S/C-1 HOP-3X2FGE-S/C-1	Ⓞ Straight: 89.5" w x 60.5" h x 12.25" d Curved: 92" w x 60.5" h x 23" d
2 1/2' full height	HOP-1X3FG-S-1 HOP-1X3FGE-S-1	Ⓞ Straight: 31" w x 90" h x 29" d
5' full height	HOP-2X3FG-S/C-1 HOP-2X3FGE-S/C-1	Ⓞ Straight: 60.5" w x 90" h x 29" d Curved: 64" w x 89.5" h x 18" d
7 1/2' full height	HOP-3X3FG-S/C-1 HOP-3X3FGE-S/C-1	Ⓞ Straight: 89.5" w x 90" h x 29" d Curved: 92" w x 89.5" h x 23" d
7 1/2' extra tall	HOP-3X4FG-S/C-1 HOP-3X4FGE-S/C-1	Ⓞ Straight: 90" w x 119" h x 29" d Curved: 92" w x 119" h x 23" d

size	code	assembled dimensions
10' full height	HOP-4X3FG-S/C-1 HOP-4X3FGE-S/C-1	Ⓞ Straight: 119" w x 90" h x 29" d Curved: 116.25" w x 89.5" h x 33" d
10' extra tall	HOP-4X4FG-S/C-1 HOP-4X4FGE-S/C-1	Ⓞ Straight: 119" w x 119" h x 29" d Curved: 116.25" w x 119" h x 33" d
12 1/4' full height	HOP-5X3FG-S/C-1 HOP-5X3FGE-S/C-1	Ⓞ Straight: 147.25" w x 90" h x 29" d Curved: 136.5" w x 89.5" h x 42" d
12 1/4' extra tall	HOP-5X4FG-S/C-1 HOP-5X4FGE-S/C-1	Ⓞ Straight: 147.8" w x 119" h x 29" d Curved: 136.5" w x 119" h x 42" d
15' full height	HOP-6X3FG-S/C-1 HOP-6X3FGE-S/C-1	Ⓞ Straight: 178" w x 90" h x 29" d Curved: 154" w x 89.5" h x 61.25" d
20' full height	HOP-8X3FG-S-1 HOP-8X3FGE-S-1	Ⓞ Straight: 235.43" w x 90" h x 29" d
30' full height	HOP-12X3FG-S-1 HOP-12X3FGE-S-1	Ⓞ Straight: 352.28" w x 90" h x 29" d

additional sizes available

HOPUP™ COUNTER



- collapsible display counter
- easy to assemble
- includes clear internal shelf
- top available in four color options

code	assembled dimensions
HOP-CT-2	Ⓞ 41.75" w x 39.69" h x 14.25" d

Hopup counter tops are available in your choice of four color options

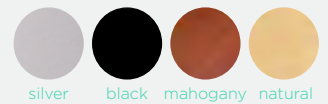

Accessorize

HOPUP™ DIMENSION KITS



KIT 01

- 7 1/2' full height straight backwall
- 2 stand-off rigid graphic accents with literature holders
- monitor* mount supports 23" monitor, max weight = 30 lbs
- 2 x LED lights

size	code	assembled dimensions
7 1/2' full height	HOP-DIM01-3X3FG-S HOP-DIM-01	Ⓞ 12"w x 37"h x 4.5"d



KIT 02

- 7 1/2' full height straight backwall
- stand-off counter supports max 35 lbs
- counter features graphic and literature holder
- monitor* mount supports 23" monitor, max weight = 30 lbs
- 2 x LED lights

size	code	assembled dimensions
7 1/2' full height	HOP-DIM02-3X3FG-S HOP-DIM-02	Ⓞ 36"w x 36.5"h x 12.5"d

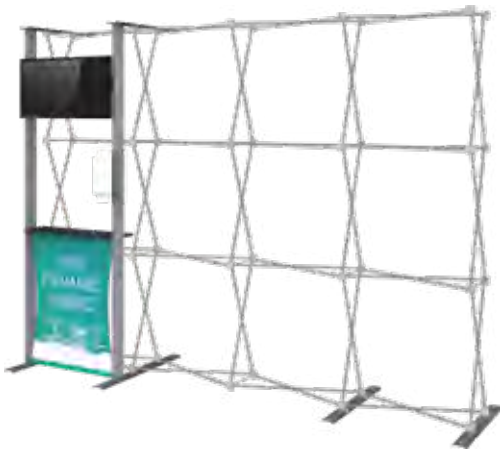

KIT 03

- 10' full height straight backwall
- accessory counter features:
 - monitor* mount supports 40" monitor, max weight = 50 lbs
 - counter top holding max weight of 35 lbs
 - printed fabric graphic and literature holder
- 2 x LED lights

size	code	assembled dimensions
10' full height	HOP-DIM03-4X3FGE-S HOP-DIM-03	Ⓞ 34"w x 90.38"h x 11.25"d

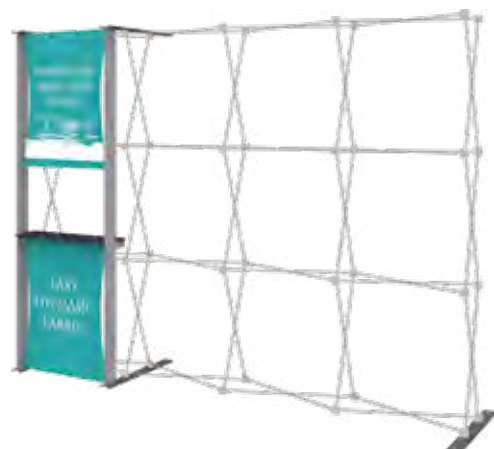

KIT 04

- 10' full height straight backwall
- standoff counter features:
 - fabric graphic messaging area (top)
 - printed fabric graphic (bottom)
 - counter top holding max weight of 35 lbs
- 2 x LED lights

size	code	assembled dimensions
10' full height	HOP-DIM04-4X3FGE-S HOP-DIM-04	Ⓞ 30"w x 90.38"h x 11.25"d



Fast & Easy

The Hopup™ Lite features an economy, lightweight collapsible frame, yellow locking arms and a front only or full-fitted fabric graphic. Hopup Lite is available in 7 ½' and 10' wide straight configurations and comes with a soft carry bag. No tools are required for assembly, simply expand the frame, lock the arms and go!

*A fast, economy
collapsible display*

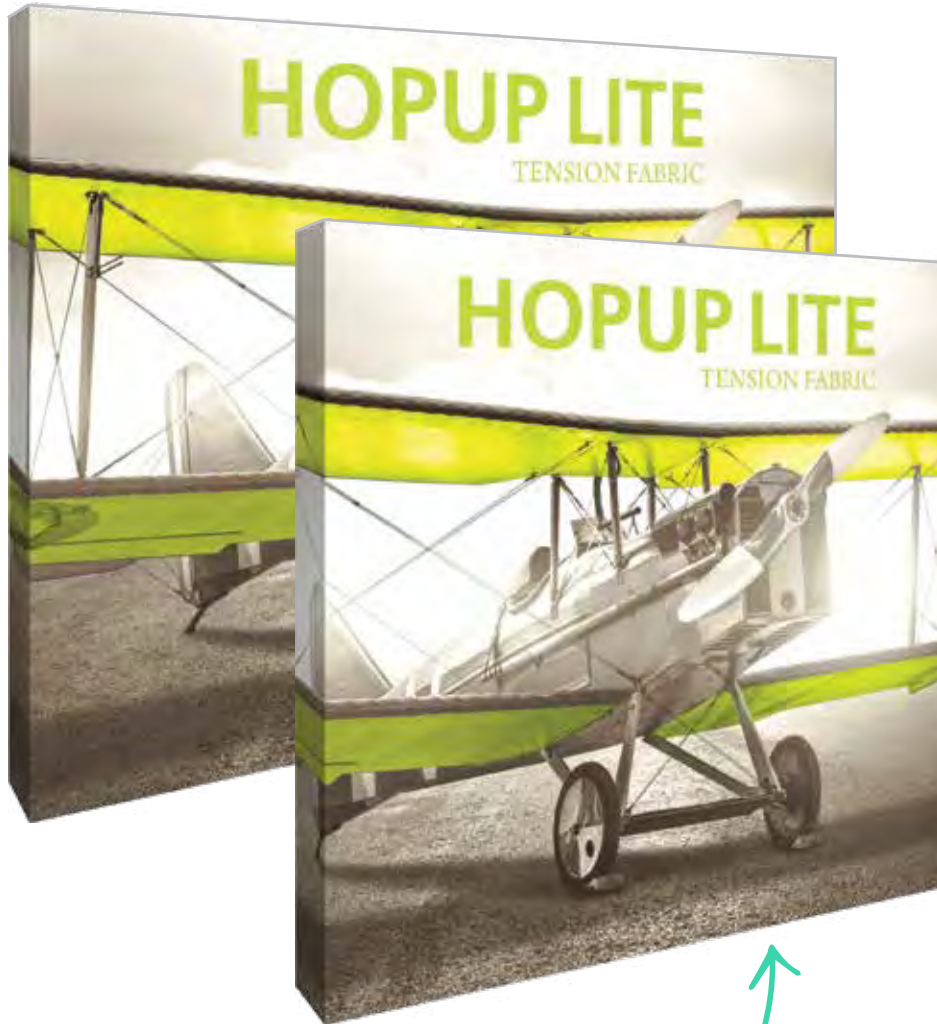

comes in two sizes



lightweight frame
assembles without tools



quickly & easily snap
locking arms into place



hook & loop graphic is
pre-attached, making setup simple

Size Options

size	code	assembled dimensions
7 1/2' full height	HOP-LITE-3X3-FG-S HOP-LITE-3X3-FGE-S	Ⓞ 89.25" w x 89.5" h x 12" d
10' full height	HOP-LITE-4X3-FG-S HOP-LITE-4X3-FGE-S	Ⓞ 118.5" w x 89.5" h x 12" d

Illuminate!

BACKLIT HOPUP™

- lightweight silver frame
- supports an integrated full-fitted fabric graphic mural with end caps and includes back liner
- available in 5' Tabletop, 2 1/2', 7 1/2' or 10' full height sizes (straight only)
- patented LED lights connect easily to scissors on top & bottom for even light distribution
- comes in an OCX molded case

four sizes to choose from!

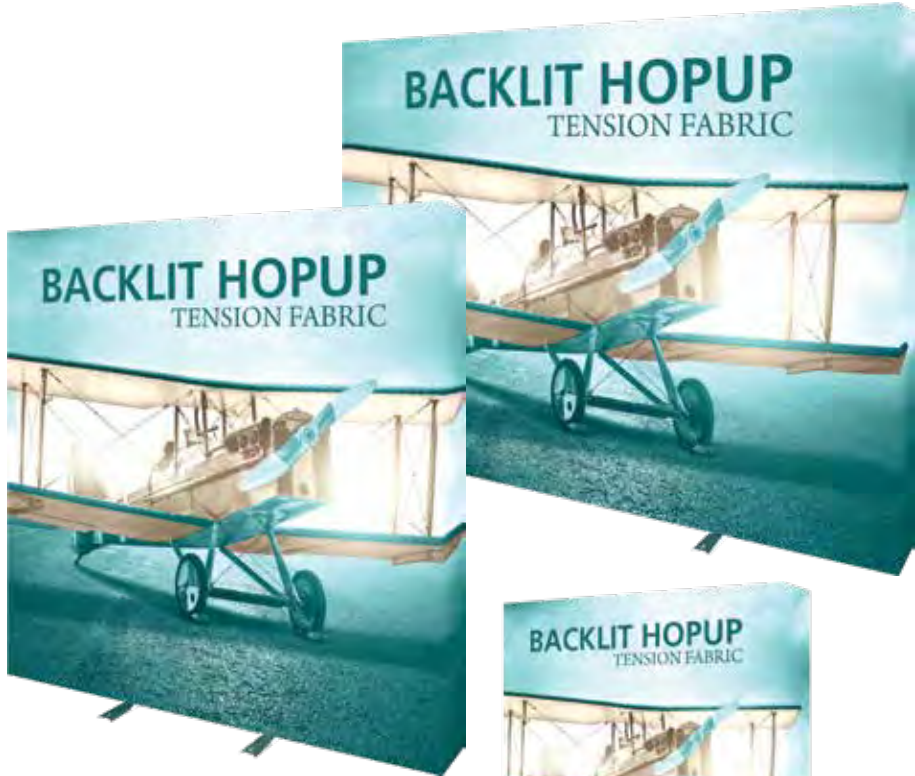

quickly & easily snap locking arms into place

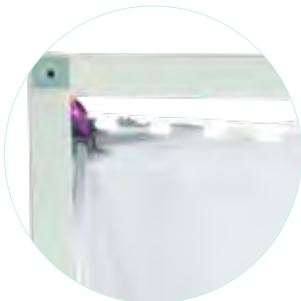

simple LED light attachment to frame



Size Options

size	code	assembled dimensions
5' tabletop kit	HOP-2-BL-2X2-S	Ⓜ Straight: 60.5" w x 31" h x 12" d
2 1/2' kit	HOP-2-BL-1X3-S	Ⓜ Straight: 31" w x 90" h x 29" d
7 1/2' kit	HOP-2-BL-3X3-S	Ⓜ Straight: 89.5" w x 90" h x 29" d
10' kit	HOP-2-BL-4X3-S	Ⓜ Straight: 119" w x 90" h x 29" d





EMBRACE™

push-fit tension fabric



Sleek & Seamless

Embrace™ is one of the sleekest collapsible portable displays and it delivers style with minimal effort. Embrace Fabric Displays come in a variety of sizes and are offered with or without endcaps. Embrace requires no tools for assembly, is lightweight and highly portable. Embrace features crisp, straight edges due to the simple, push-fit SEG fabric graphic attachment.

Two choices of graphic style

WITH OR WITHOUT ENDCAPS



Details

- lightweight anodized white frame
- stabilizer feet on all frames 3 quads high
- simple assembly
- perimeter channel bars connect to frame and hold push-fit fabric graphic
- crisp, push-fit SEG fabric graphic creates clean, straight edges; comes with front or fully fitted graphic (with end caps)
- carry bag included



quickly & easily snap locking arms into place

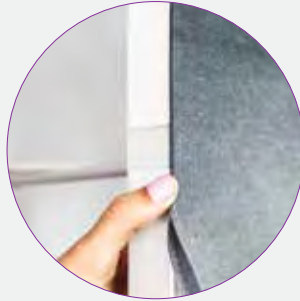

easy push-fit fabric graphics go into channel

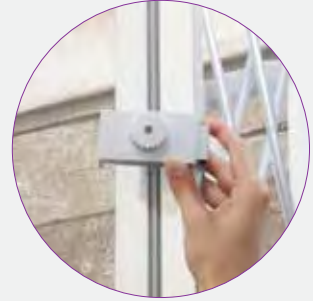

clamps can be used to connect multiple walls



carry bag included with most kits



add a counter - the perfect addition to any Embrace backwall display



optional upgrade - Lumina 200 light



Choose a size that's right for you!



TABLETOP



FLOOR BACKWALL



EXTRA LONG

Size Options

size	code	assembled dimensions
2 1/2' tabletop	EMB-1X1FG-S EMB-1X1FGE-S	Ⓞ 31.25" w x 31.38" h x 14.5" d
5' tabletop	EMB-2X1FG-S EMB-2X1FGE-S	Ⓞ 59.81" w x 31.38" h x 14.5" d
5' tabletop	EMB-2X2FG-S EMB-2X2FGE-S	Ⓞ 59.81" w x 60" h x 14.5" d
7 1/2' tabletop	EMB-3X2FG-S EMB-3X2FGE-S	Ⓞ 88.5" w x 60" h x 14.5" d
2 1/2' full height	EMB-1X3FG-S EMB-1X3FGE-S	Ⓞ 31.25" w x 88.94" h x 23.25" d
5' full height	EMB-2X3FG-S EMB-2X3FGE-S	Ⓞ 59.81" w x 88.94" h x 23.25" d
7 1/2' full height	EMB-3X3FG-S EMB-3X3FGE-S	Ⓞ 88.5" w x 88.94" h x 23.25" d

size	code	assembled dimensions
7 1/2' extra tall	EMB-3X4FG-S EMB-3X4FGE-S	Ⓞ 88.5" w x 118" h x 23.25" d
10' full height	EMB-4X3FG-S EMB-4X3FGE-S	Ⓞ 88.5" w x 118" h x 23.25" d
10' extra tall	EMB-4X4FG-S EMB-4X4FGE-S	Ⓞ 117" w x 118" h x 23.25" d
12 1/4' full height	EMB-5X3FG-S EMB-5X3FGE-S	Ⓞ 146" w x 88.94" h x 23.25" d
15' wide	EMB-6X3FG-S EMB-6X3FGE-S	Ⓞ 178" w x 88.94" h x 23.25" d
20' wide	EMB-8X3FG-S EMB-8X3FGE-S	Ⓞ 230.31" w x 88.94" h x 23.25" d
30' wide	EMB-12X3FG-S EMB-12X3FGE-S	Ⓞ 345.47" w x 88.94" h x 23.25" d

EMBRACE™ COUNTER



white shelf

- collapsible display counter
- includes internal shelf
- push-fit fabric graphics
- top available in four laminate finish options

code	assembled dimensions
EMB-CT EMB-CT-BL	Ⓞ 41" w x 40.5" h x 15.75" d

Embrace counter tops are available in your choice of four color options



Accessorize

EMBRACE MONITOR MOUNT

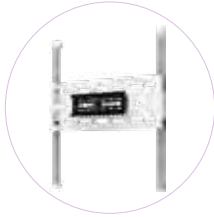

- monitor bracket supports 30 lbs
- compatible with Embrace frames 3 quads high
- backwall not included

EMBRACE TABLE



- accessory table includes frame, tabletop and graphics (2 pieces)
- tabletop offered in black
- compatible with Embrace frames 3 quads high
- backwall not included
- comes with carry bag

EMBRACE SHELVING



- shelf supports 10 lbs
- compatible with Embrace frames 3 quads high
- perfect for displaying lightweight products or giveaways
- backwall not included
- comes with carry bag

BRIDGE CONNECTOR



- bridge connector uses a simple S-shape connection
- simply slip on the frames and tighten
- two connectors recommended per side

BRIDGE LIGHT/LIGHT KIT



- illuminate the Embrace Bridge with a Light Kit
- call attention to your display and stand out
- kit includes 3 lights
- comes with carry bag

EMBRACE BRIDGE



- bridge includes frame and graphics (2 pieces)
- compatible with Embrace frames 3 quads high
- accent adds dimension and additional messaging opportunity
- backwalls not included
- comes with carry bag

illuminate your Embrace Bridge!

size	code	assembled dimensions
Embrace Monitor Mount	EMB-MM	Ⓞ 24.48" w x 29.92" h x 2.76" d
Embrace Table	EMB-TBL-BLACK	Ⓞ 14.96" w x 38.66" h x 47.25" d
Embrace Shelving	EMB-EXT-SHLF-K-1 EMB-EXT-SHLF-K-2	Ⓞ 26.41" w x 9.88" d
Embrace Bridge Connector	EMB-BRIDGE-CONNECTOR	Ⓞ N/A
Embrace Bridge Light/Light Kit	EMB-BRIDGE-LT EMB-BRIDGE-LT-KIT	Ⓞ 30" w x 1.5" h x 6" d
Embrace Bridge	EMB-BRIDGE	Ⓞ 30.71" w x 7.90" h x 88.15" d



Bright & Impactful

The Backlit Embrace™ display system is revolutionary! The patented light system is simple to use and provides bright, even light throughout the display. This display is guaranteed to attract attention at any trade show or in any interior space.



illuminate to attract attention!



display pops up in minutes



simple-to attach LED lights

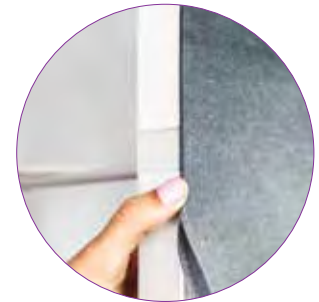

easy push-fit fabric graphics go into channel

Details

- patented LED lights are simple to attach & provide even, bright white lighting
- lightweight, white aluminum frame (same frame as non-illuminated kits)
- supports a single or double-sided backlit push-fit fabric graphic with end caps
- comes with OCX hard case for ultimate protection during transport & storage

Size Options

size	code	assembled dimensions
5' tabletop	EMB-BL-2X2-S	Ⓞ 59.81" w x 60" h x 14.5" d
2 1/2' full height	EMB-BL-1X3-S	Ⓞ 31.25" w x 88.94" h x 23.25" d
5' full height	EMB-BL-2X3-S	Ⓞ 59.81" w x 88.94" h x 23.25" d
7 1/2' full height	EMB-BL-3X3-S	Ⓞ 88.5" w x 88.94" h x 23.25" d
10' full height	EMB-BL-4X3-S	Ⓞ 117" w x 88.94" h x 23.25" d
12 1/4' full height	EMB-BL-5X3-S	Ⓞ 146" w x 88.94" h x 23.25" d
20' wide	EMB-BL-8X3-S	Ⓞ 230.31" w x 88.94" h x 23.25" d

Backlighting kits also available a la carte!



Quick & Simple

The Embrace™ Lite display features an economy, lightweight collapsible frame, channel bars that hold the push-fit fabric graphic and portable carry bag. Embrace Lite is available in 7½' and 10' wide sizes. No tools are required for assembly. Simply expand the frame, attach the channel bars, attach the fabric graphics and you're done!

An economy push-fit fabric display



lightweight frame assembles without tools

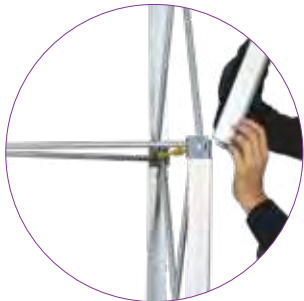

perimeter channel bars connect together with ease



stabilizer feet and carry bag included

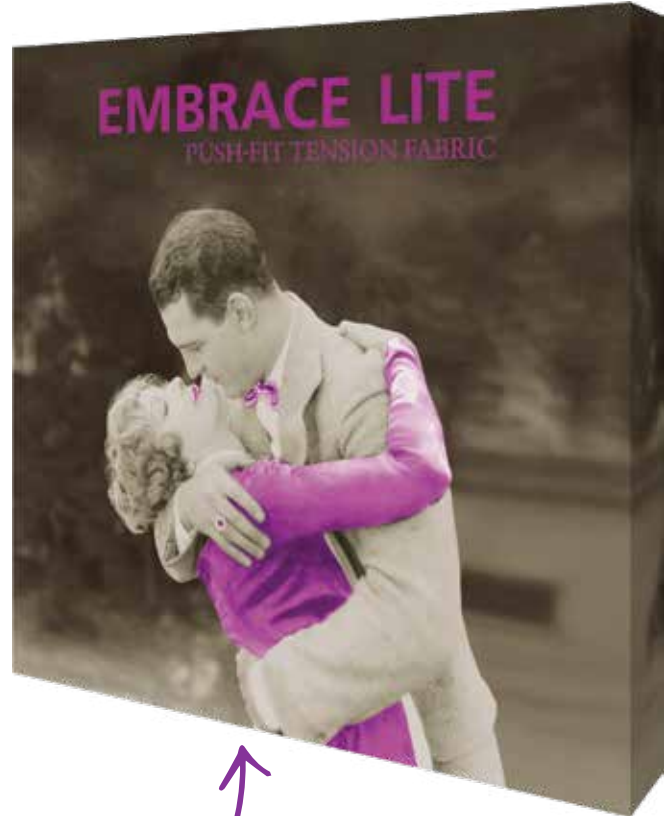

comes in two sizes

Size Options

size	code	assembled dimensions
7 1/2' full height	EMB-LITE-3X3FG-S EMB-LITE-3X3FGE-S	Ⓞ 88.5" w x 88.63" h x 13.54" d
10' full height	EMB-LITE-4X3FG-S EMB-LITE-4X3FGE-S	Ⓞ 117.5" w x 88.63" h x 13.54" d





XCLAIM™

fabric popup

Polished & Versatile

The Xclaim™ fabric popup system features super stretch push-fit fabric graphics that come pre-attached to the collapsible frame to create sleek, polished displays. Displays are available in a variety of sizes and configurations, and the multitude of placement possibilities of the push-fit fabric graphics are endless and customizable! Using a lightweight magnetic collapsible frame, Xclaim displays require no tools for assembly, are portable, durable and set up and pack down fast.

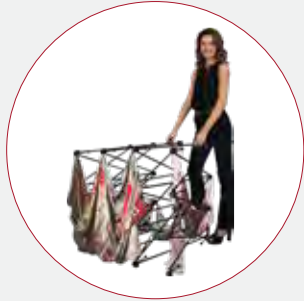

frame is lightweight and portable



magnetic arms for simple assembly



graphics adhere to hubs using push-fit technology



add an optional shelf, available in four color options



lightweight & portable, making transport easy



optional upgrade - Lumina 200 light

Tabletop Kits



5' tabletop
XCLM-2X2-K1



5' tabletop
XCLM-2X2-K2



5' tabletop
XCLM-2X2-K3



5' tabletop
XCLM-2X2-K4

size	code	assembled dimensions
5' tabletop	XCLM-2X2-K1	Ⓞ 59.11" w x 59.42" h x 12.8" d
5' tabletop	XCLM-2X2-K2	Ⓞ 59.11" w x 59.42" h x 12.8" d
5' tabletop	XCLM-2X2-K3	Ⓞ 59.11" w x 59.42" h x 12.8" d
5' tabletop	XCLM-2X2-K4	Ⓞ 59.11" w x 59.42" h x 12.8" d

Full Height Kits



2 1/2' full height display
XCLM-1X3-K1



2 1/2' full height display
XCLM-1X3-K2



2 1/2' full height display
XCLM-1X3-K3



2 1/2' full height display
XCLM-1X3-K4



5' full height display
XCLM-2X3-K1



5' full height display
XCLM-2X3-K2

size	code	assembled dimensions
2 1/2' full height	XCLM-1X3-K1	⊗ 30.30" w x 88.23" h x 12.8" d
2 1/2' full height	XCLM-1X3-K2	⊗ 30.30" w x 88.23" h x 12.8" d
2 1/2' full height	XCLM-1X3-K3	⊗ 30.30" w x 88.23" h x 12.8" d
2 1/2' full height	XCLM-1X3-K4	⊗ 30.30" w x 88.23" h x 12.8" d
5' full height	XCLM-2X3-K1	⊗ 59.11" w x 88.23" h x 12.8" d
5' full height	XCLM-2X3-K2	⊗ 59.11" w x 88.23" h x 12.8" d

Full Height Kits



7 1/2' full height display
XCLM-3X3-K1



7 1/2' full height display
XCLM-3X3-K2



7 1/2' full height display
XCLM-3X3-K3



7 1/2' full height display
XCLM-3X3-K4



7 1/2' full height display
XCLM-3X3-K5



7 1/2' full height display
XCLM-3X3-K6

Full Height Kits



10' full height display
XCLM-4X3-K1



10' full height display
XCLM-4X3-K2



10' full height display
XCLM-4X3-K3

size	code	assembled dimensions
7 1/2' full height	XCLM-3X3-K1	Ⓞ 87.92" w x 88.23" h x 12.8" d
7 1/2' full height	XCLM-3X3-K2	Ⓞ 87.92" w x 88.23" h x 12.8" d
7 1/2' full height	XCLM-3X3-K3	Ⓞ 87.92" w x 88.23" h x 12.8" d
7 1/2' full height	XCLM-3X3-K4	Ⓞ 87.92" w x 88.23" h x 12.8" d
7 1/2' full height	XCLM-3X3-K5	Ⓞ 87.92" w x 88.23" h x 12.8" d
7 1/2' full height	XCLM-3X3-K6	Ⓞ 87.92" w x 88.23" h x 12.8" d
10' full height	XCLM-4X3-K1	Ⓞ 116.72" w x 88.23" h x 12.8" d
10' full height	XCLM-4X3-K2	Ⓞ 116.72" w x 88.23" h x 12.8" d
10' full height	XCLM-4X3-K3	Ⓞ 116.72" w x 88.23" h x 12.8" d



Full Height Kits

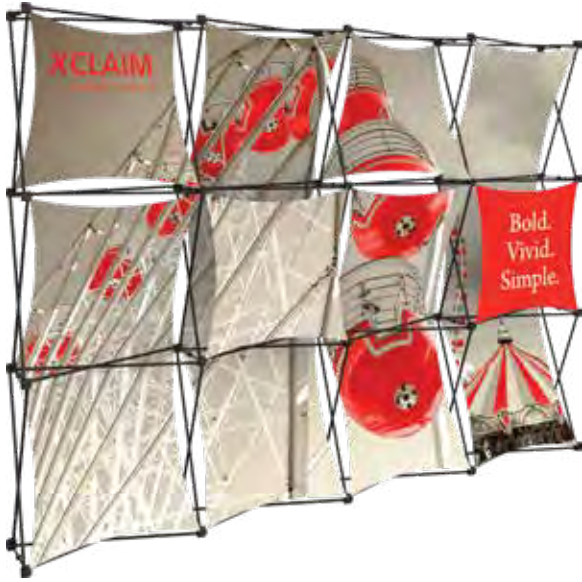

10' full height display
XCLM-4X3-K4



10' full height display
XCLM-4X3-K5



10' full height display
XCLM-4X3-K6



add an optional shelf,
available in four color options



size	code	assembled dimensions
10' full height	XCLM-4X3-K4	Ⓞ 116.72" w x 88.23" h x 12.8" d
10' full height	XCLM-4X3-K5	Ⓞ 116.72" w x 88.23" h x 12.8" d
10' full height	XCLM-4X3-K6	Ⓞ 116.72" w x 88.23" h x 12.8" d

Pyramid Kits

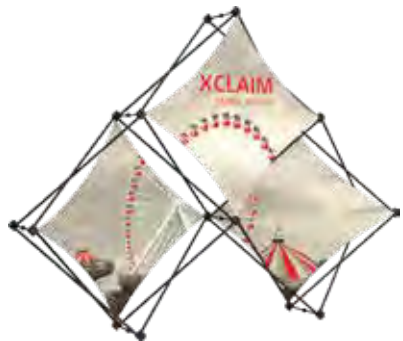

7' display
XCLM-3QP-K1



7' display
XCLM-3QP-K2



10' display
XCLM-6QP-K1



10' display
XCLM-6QP-K2



14' full height display
XCLM-10QP-K1

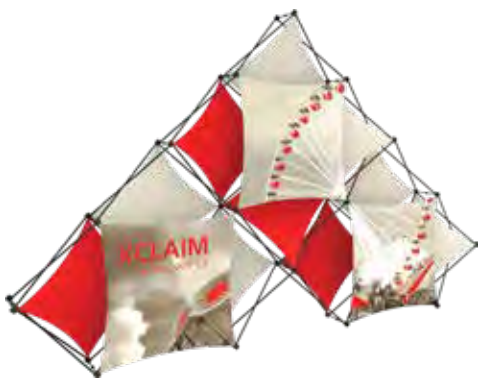

14' full height display
XCLM-10QP-K2

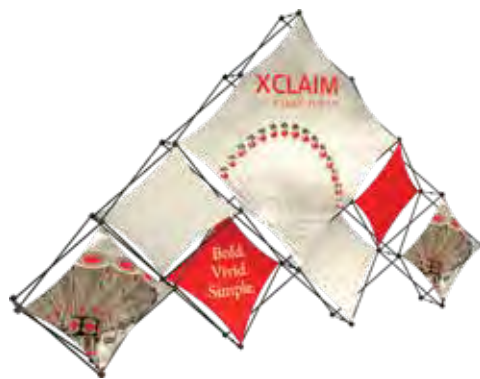

14' full height display
XCLM-10QP-K3

size	code	assembled dimensions
7' full height	XCLM-3QP-K1	Ⓞ 83.51" w x 63.14" h x 12.8" d
7' full height	XCLM-3QP-K2	Ⓞ 83.51" w x 63.14" h x 12.8" d
10' display	XCLM-6QP-K1	Ⓞ 124.25" w x 83.51" h x 12.8" d
10' display	XCLM-6QP-K2	Ⓞ 124.25" w x 83.51" h x 12.8" d
14' full height	XCLM-10QP-K1	Ⓞ 164.99" w x 103.88" h x 12.8" d
14' full height	XCLM-10QP-K2	Ⓞ 164.99" w x 103.88" h x 12.8" d
14' full height	XCLM-10QP-K3	Ⓞ 164.99" w x 103.88" h x 12.8" d





COYOTE™

popup display systems



Reliable & Durable

This fully magnetic popup display system provides a graphic or hook & loop receptive fabric backwall. Coyote™ popup displays require no tools for assembly, are portable, versatile, durable and easy to use. The Coyote line features a plethora of accessory options to add such as shelves, monitor mounts and case-to-counter conversion kits and graphics.



frame is lightweight and portable



magnetic arms for simply assembly



rollable graphic panels adhere effortlessly using magnets

fabric choices

All Coyote popup display systems are available with printed graphic murals or "hook & loop-friendly" fabric panels of your choice. Actual fabric color may vary slightly.

REGAL - SMOOTH EXHIBIT & DISPLAY FABRIC

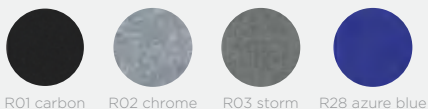

R01 carbon R02 chrome R03 storm R28 azure blue

PREMIER - RIBBED EXHIBIT & DISPLAY FABRIC

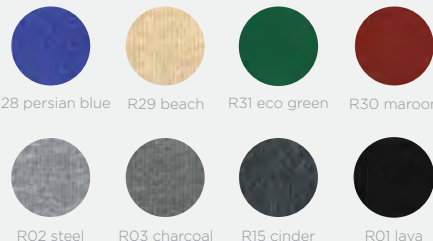

R28 persian blue R29 beach R31 eco green R30 maroon

R02 steel R03 charcoal R15 cinder R01 lava



Popup Display Size Options



4'w tabletop
COY-KKG-1X1-C



6'w tabletop
COY-KKG-2X1-C



6'w tabletop
COY-KKG-2X2-C



8'w tabletop
COY-KKG-3X2-C



6'w full height
slim-line display system
COY-KKG-2X3-C



8'w full height
standard display system
COY-KKG-3X3-C



8'w serpentine
full height display system
COY-KKG-ST-8



10'w full height
standard display system
COY-KKG-4X3-C



11'w serpentine
full height display system
COY-KKG-ST-10



11'w standard horseshoe
full height exhibit system
COY-KKG-HS



17'w deluxe horseshoe
full height exhibit system
COY-KKG-DHS



20'w gullwing
full height exhibit system
COY-KKG-GW



20'w serpentine
full height exhibit system
COY-KKG-SPNT

Accessorize



INTERNAL SHELF KIT

- presents products or literature
- comes with 2 clear acrylic shelves to be used horizontally or at 45° angles
- max capacity per shelf = 15 lbs, max per quadrant = 45 lbs
- for use with curved frame only
- lighting package available (not to be stored with display)



MONITOR MOUNT

- fully integrates with straight or curved Coyote™ systems
- one panel cut to fit the monitor*
- VESA bolt compatible
- max weight = 50 lbs
- LCD max size = 23"

Convert your counter!



OCX

- premium latches for maximum strength
- roto molded transit case
- built in wheels, handle
- UPS approved
- optional wood counter available (see p. 154)



ROLL WRAP

- available in carpet or graphic
- converts OCX to a counter
- polymer counter surface exposed
- optional wood counter top can be added in your choice of silver, black, mahogany or natural



STRETCH WRAP

- stretch fabric pullover
- converts OCX to a counter
- polymer counter surface covered by fabric

size/name	code	assembled dimensions
4' wide tabletop	COY-KKG-1X1-C	Ⓞ 45.5" w x 30.63" h x 12.5" d
6' wide tabletop	COY-KKG-2X1-C	Ⓞ 73" w x 30.63" h x 19.25" d
6' wide tabletop	COY-KKG-2X2-C	Ⓞ 73" w x 59.38" h x 19.25" d
8' wide tabletop	COY-KKG-3X2-C	Ⓞ 97.25" w x 59.38" h x 25" d
6' wide full height	COY-KKG-2X3-C	Ⓞ 73" w x 87.56" h x 19.25" d
8' wide full height	COY-KKG-3X3-C	Ⓞ 97.25" w x 87.56" h x 25" d
8' wide serpentine	COY-KKG-ST-8	Ⓞ 102" w x 87.56" h x 20.25" d
10' wide full height	COY-KKG-4X3-C	Ⓞ 118" w x 87.56" h x 36.5" d
11' wide serpentine	COY-KKG-ST-10	Ⓞ 129" w x 87.56" h x 22" d

size/name	code	assembled dimensions
11' wide standard horseshoe	COY-KKG-HS	Ⓞ 113" w x 87.56" h x 54" d
17' wide deluxe horseshoe	COY-KKG-DHS	Ⓞ 193.5" w x 87.56" h x 59.5" d
20' wide gullwing	COY-KKG-GW	Ⓞ 45.5" w x 30.63" h x 12.5" d
20' wide serpentine	COY-KKG-SPNT	Ⓞ 73" w x 30.63" h x 19.25" d
internal shelf kit	COY-IS-CK	Ⓞ 73" w x 59.38" h x 19.25" d
monitor mount	COY-MM	Ⓞ 97.25" w x 59.38" h x 25" d
OCX	OCX	Ⓞ 73" w x 87.56" h x 19.25" d
OCX roll wrap	OCX-C2C-G	Ⓞ 97.25" w x 87.56" h x 25" d
OCX stretch wrap	OCX-SW-G	Ⓞ 102" w x 87.56" h x 20.25" d





MODULATE[®] *magnetic*

Unique & Functional

Modulate® allows for customized configurations of banners and backwalls with the use of **MAGNETIZED** frames. Aluminum tube frames are coupled with zipper pillowcase fabric graphics to create versatile, eye-catching displays.

mix and match multiple uniquely shaped banners

CHOOSE FROM CONVEX, CONCAVE AND STRAIGHT



Simply assemble frames, add graphics and place desired frames next to one another!

magnetized connection

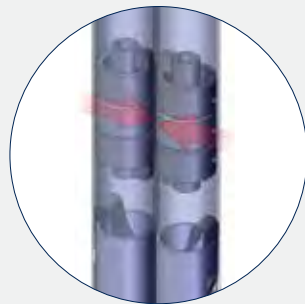

high-powered internal magnets for connection of frames



Mix & Match

CONVEX & CONCAVE SHAPED BANNERS



BANNER 1



BANNER 2



BANNER 3



BANNER 4



BANNER 5



BANNER 6

Size Options

size/name	code	assembled dimensions
Banner 1	MOD-FRM-01-M-TL	60" w x 96" h x 19" d
Banner 2	MOD-FRM-02-M-TL	60" w x 96" h x 19.3" d
Banner 3	MOD-FRM-03-M-TL	35" w x 96" h x 17.72" d
Banner 4	MOD-FRM-04-M-TL	35" w x 96" h x 17.72" d
Banner 5	MOD-FRM-05-M-TL	112.58" w x 92.36" h x 31.23" d
Banner 6	MOD-FRM-06-M-TL	45.74" w x 96" h x 17.72" d
Banner 7	MOD-FRM-07-M-TL	90.78" w x 92" h x 17.72" d
Banner 8	MOD-FRM-08-M-TL	46.7" w x 92" h x 17.72" d
Banner 9	MOD-FRM-09-M-TL	66.74" w x 96" h x 17.72" d
Banner 10	MOD-FRM-10-M-TL	32.74" w x 96" h x 17.72" d
Banner 11	MOD-FRM-11-M-TL	43.74" w x 92" h x 17.72" d
Banner 12	MOD-FRM-12-M-TL	96.34" w x 48.39" h x 17.72" d
Banner 13	MOD-FRM-13-M-TL	48.74" w x 96" h x 17.72" d
Banner 14	MOD-FRM-14-M-TL	96.7" w x 96" h x 17.7" d

MODULATE COUNTER



- magnetic, tubular frame with snap buttons
- fabric graphic attaches via hook and loop around the frame & zips in the back
- internal shelf provides area to store materials
- portable carry bag makes transport simple
- counter top is available in your choice of four color options

code	assembled dimensions
MOD-CNTR-M	31.5" w x 40" h x 23.5" d

Design Your Own Combinations

STRAIGHT BANNERS

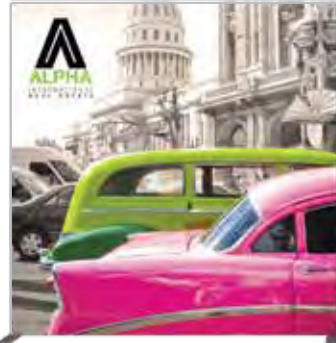

BANNER 7



BANNER 8



BANNER 9



BANNER 10



BANNER 11



BANNER 12



BANNER 13



BANNER 14

Accessorize

MODULATE DOOR



door handle

code	assembled dimensions
MOD-CNTR-M	31.5" w x 40" h x 23.5" d

ACCENT LADDERS



code	assembled dimensions
MOD-CNTR-M	31.5" w x 40" h x 23.5" d



Reconfigure For Your Needs!

If you have a tradeshow schedule where you have multiple size spaces to plan for, Modulate® pre-defined 30' inline kits can reconfigure easily into smaller exhibit sizes with no extra parts or packaging! **MAGNETIC** frames connect quickly and easily. **Maximize your value in a versatile, reconfigurable system.**

CONVERT A 30' INLINE



MOD-30-02-M-TL

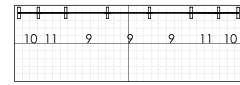

INTO A 20' INLINE



MOD-20-02-M-TL

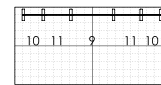

OR TWO 10' INLINE DISPLAYS



MOD-10-03-M-TL



MOD-10-04-M-TL



Reconfigure For Your Needs!

CONVERT A 30' INLINE

MOD-30-01-M-TL

INTO A 20' INLINE

MOD-20-01-M-TL
Kit includes banners 3, 6, 5, 6

OR TWO 10' INLINE DISPLAYS

MOD-10-01-M-TL
Kit includes banners 4, 6, 3

MOD-10-02-M-TL
Kit includes banners 6, 4, 3

Modulate uses universal, patented magnetic connectors!

CONVERT A 30' INLINE

MOD-30-03-M-TL

INTO A 20' INLINE

MOD-20-03-M-TL
Kit includes banners 11, 10, 7, 10, 11

OR TWO 10' INLINE DISPLAYS

MOD-10-05-M-TL
Kit includes banners 11, 10, 11

MOD-10-06-M-TL
Kit includes banners 9 & 10





Snips



FORMULATE[®] *essential*

Sleek & Portable

Formulate® Essential banner displays feature basic tubular frames coupled with pillowcase fabric graphics. The economy tube frames come with a one year limited warranty. Simply pull the graphic over the frame.



- standard depth = 14.75"
- offered in seven widths
- straight aluminum tube frame
- rounded corners
- bungee cords for easy assembly
- sturdy feet anchor the display
- comes with single or double-sided pillowcase fabric graphic
- comes with carry bag

code	width	height	assembled dimensions
FMLT-E-S-600-2	23.5"	91.63"	⊗ 25"w x 92"h x 15"d
FMLT-E-S-800-2	31.5"	91.63"	⊗ 33"w x 92"h x 15"d
FMLT-E-S-850-2	33.5"	91.63"	⊗ 35"w x 92"h x 15"d
FMLT-E-S-920-2	36.5"	91.63"	⊗ 37.75"w x 92"h x 15"d
FMLT-E-S-1000-2	39.5"	91.63"	⊗ 40.9"w x 92"h x 15"d
FMLT-E-S-1200-2	47.25"	91.63"	⊗ 48.75"w x 92"h x 15"d
FMLT-E-S-1500-2	59"	91.63"	⊗ 60.5"w x 92"h x 15"d

comes with single or double-sided graphic

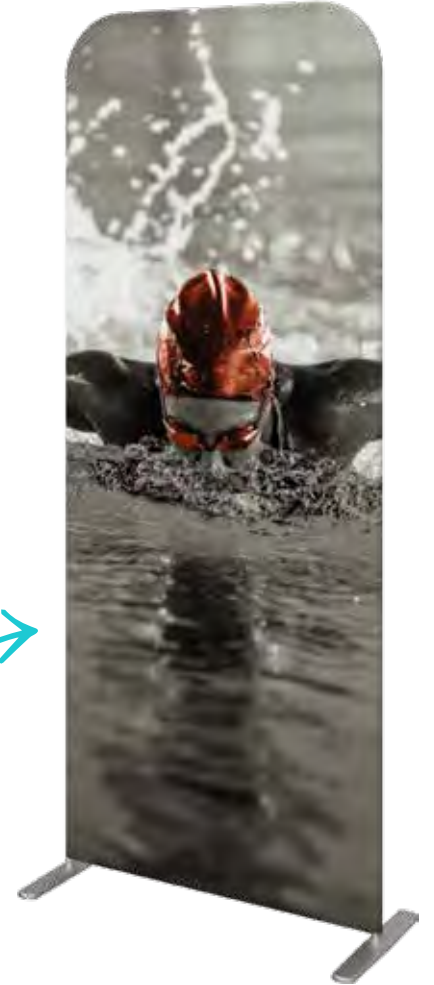

bungee corded poles allow for simple assembly



easy-to-apply pillowcase fabric graphics



Essential Displays

FORMULATE ESSENTIAL TABLETOP DISPLAYS

- Formulate® Essential Tabletop economy aluminum tube frames feature bungee cords, rounded corners and come with a one year limited warranty
- simply pull the pillowcase fabric graphic over the frame and zip
- all displays have an overall height of 5' and fit on an 8' wide table and come with a canvas carry bag

size	code	assembled dimensions
8' tabletop	FMLT-ESS-STT-01	72.25" w x 60.25" h x 17.75" d



Straight
FMLT-ESS-STT-01

FORMULATE ESSENTIAL 8' DISPLAYS

- Formulate® Essential 8' economy aluminum tube frames feature bungee cords, rounded corners and come with a one year limited warranty
- simply pull the pillowcase fabric graphic over the frame and zip
- all displays come with a canvas carry bag

size	code	assembled dimensions
8' straight	FMLT-ESS-S08-01	98.75" w x 89.25" h x 17.75" d

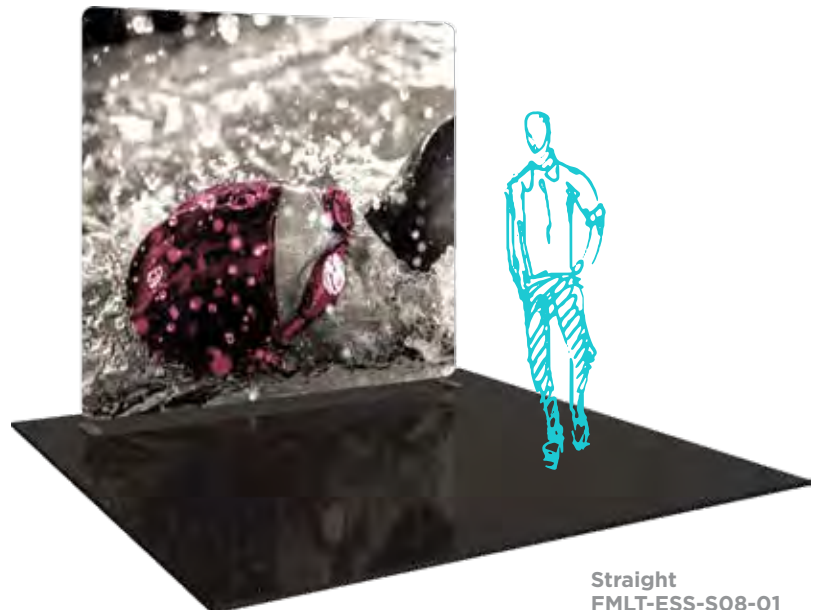

Straight
FMLT-ESS-S08-01

*Easy-to-apply
pillowcase fabric graphics!*

Essential Displays

FORMULATE ESSENTIAL 10' DISPLAYS

- Formulate® Essential 10' economy aluminum tube frames feature bungee cords, rounded corners and come with a one year limited warranty
- simply pull the pillowcase fabric graphic over the frame and zip
- all displays come with a canvas carry bag

size	code	assembled dimensions
10' straight	FMLT-ESS-S10-01	98.75" w x 89.25" h x 17.75" d
10' serpentine curved	FMLT-E-SC10-01	121" w x 89.25" h x 19" d

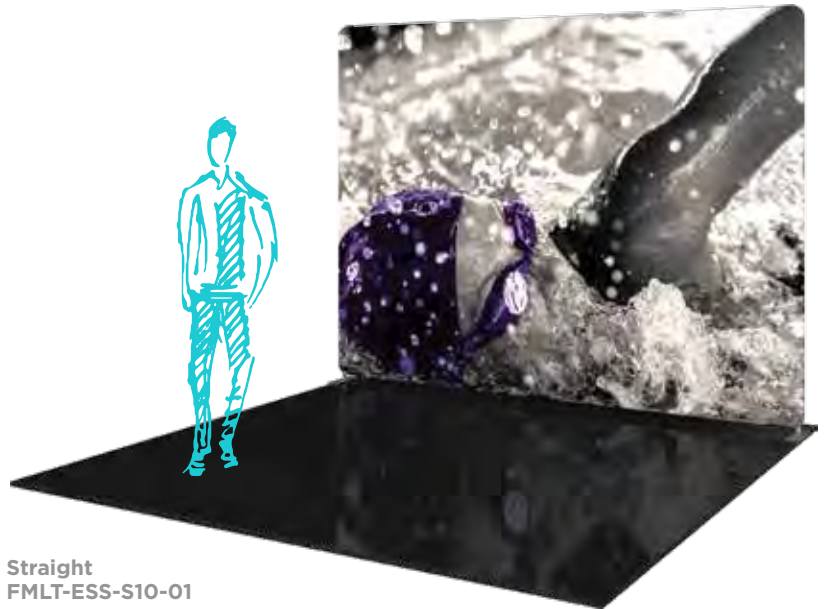

Bungee corded poles allow for simple assembly

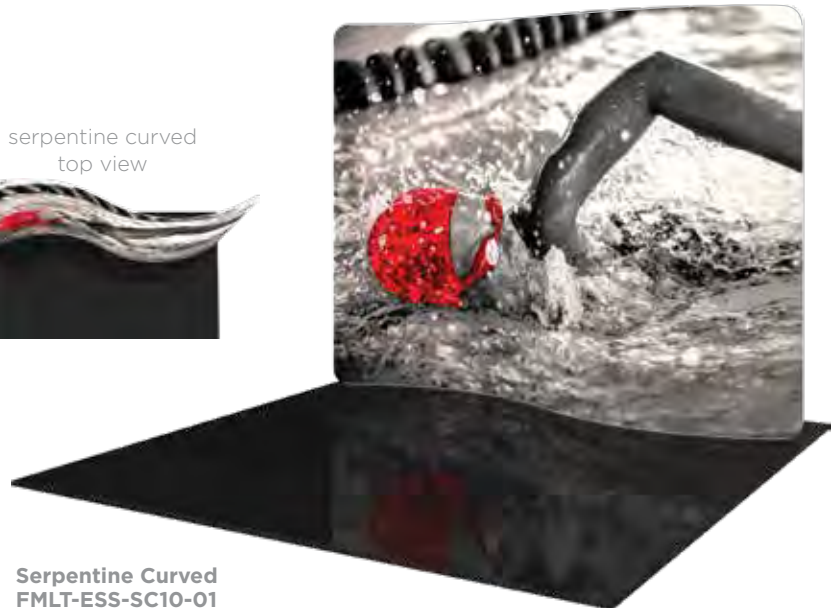
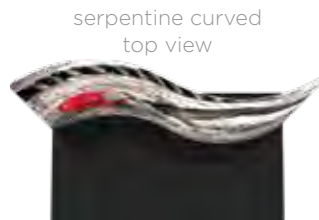



FORMULATE[®]

master



Stylish & Functional

Sophisticated yet simple, Formulate® Master 8', 10', 12', 15' and 20' Straight, Horizontal Curved, Vertical Curved and Serpentine Curved backwalls combine pillowcase fabric graphics with lightweight aluminum tube frames. Formulate Master displays are more sophisticated and robust than Formulate Essential backwalls and are designed to support a variety of accent ladders and connectors.

choose a backwall shape and size

STRAIGHT, HORIZONTAL CURVED, VERTICAL CURVED AND SERPENTINE CURVED



STRAIGHT

- 8', 10', 12', 15', 20' wide



HORIZONTAL CURVED

- 8', 10', 20' wide



VERTICAL CURVED

- 8', 10', 20' wide



SERPENTINE CURVED

- 20' wide only

Formulate displays add a professional, timeless and stylish appearance!



aluminum tube frames are lightweight for easy push-button assembly



simply pull the zipper pillowcase fabric graphics over the frame



Accessorize

First, choose from Formulate Master 10', 12', 15' & 20' backwalls. Then accessorize to add functionality, shelving and areas for more messaging.

Formulate Master backwall accents provide enhanced functionality and real estate for messaging. Choose from unique and designer options including shelving, surface areas, monitor displays and additional space for messaging.



Impress and add function to your Formulate backwall!

Accent Ladders



ACCENT 01

Pillowcase fabric graphic



ACCENT 02



Three 20" w shelves and top and bottom printed infill panels



ACCENT 03



Choice of right-hand or left-hand arm tables, no table, top and bottom printed infill panels; fits a medium sized monitor*



ACCENT 04

Features a 36" w table top, top and bottom hook & loop applied printed fabric graphics and hardware mounts for a medium sized monitor*



ACCENT 07

Two 30" w shelves and a 36" w fabric counter adds space for small products to be displayed with style

Add illumination! LED display lighting options available

size	code	assembled dimensions
Accent 01	FMLT-WL01	23.6" w x 92.7" h x 17.7" d
Accent 02	FMLT-WL02	23.6" w x 92.7" h x 26.6" d
Accent 03	FMLT-WL03-L/R	23.6" w x 92.7" h x 26.6" d
Accent 04	FMLT-WL04	37.4" w x 92.4" h x 29.4" d
Accent 07	FMLT-WL07	36" w x 93.43" h x 18.21" d



Connect

The Formulate® Master Backwall Connector is an ideal accessory to connect two 10' or 20' Formulate backwalls. It features a pillowcase fabric graphic and connects easily to create the appearance of one seamless display.

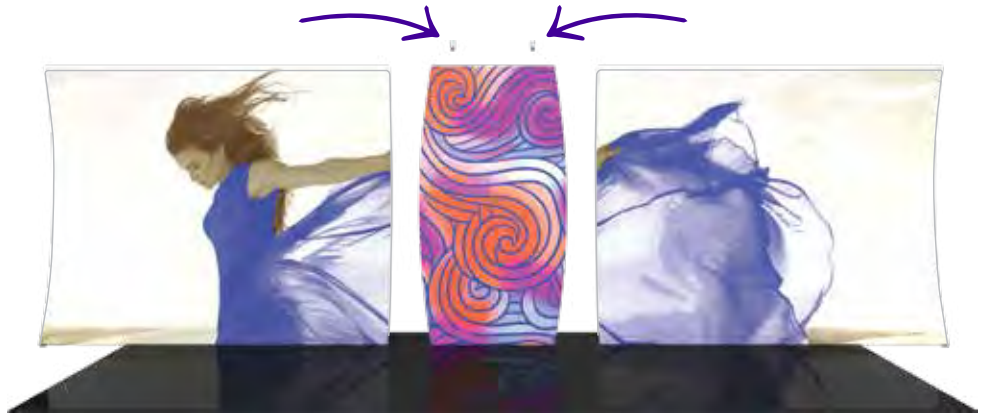

Turn your Formulate backwall into one seamless display



CONNECTOR 03

Pillowcase fabric graphic and monitor mounts for a medium sized monitor*

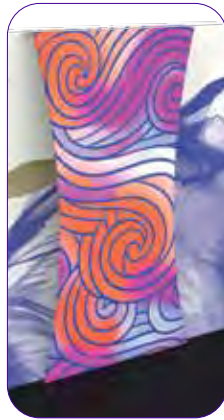
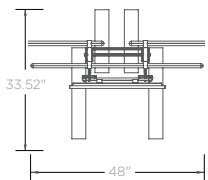

CONNECTOR 04

Pillowcase fabric graphic

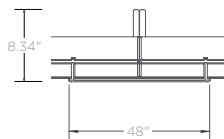

CONNECTOR 05

Pillowcase fabric graphic and monitor mounts for a medium sized monitor*

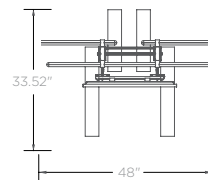

CONNECTOR 07

Pillowcase fabric graphic and monitor mount for a medium sized monitor*

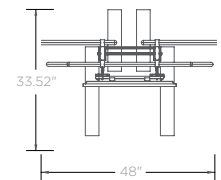

name	code	assembled dimensions
Backwall Connector	FMLT-WBWC	Ⓞ 48" w x 92.28" h x 33.52" d
Connector 03	FMLT-WBWC-03	Ⓞ 48" w x 92.28" h x 33.52" d
Connector 04	FMLT-WBWC-04	Ⓞ 48" w x 97.05" h x 8.34" d
Connector 05	FMLT-WBWC-05	Ⓞ 48" w x 92.25" h x 33.52" d
Connector 07	FMLT-WBWC-07	Ⓞ 48" w x 92.63" h x 33.52" d

*Monitors not included.

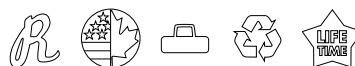

Add a Backwall Accent

BACKWALL ACCENT 04

- curved
- L-shaped pillowcase divider walls attach to any Formulate Master Straight backwall

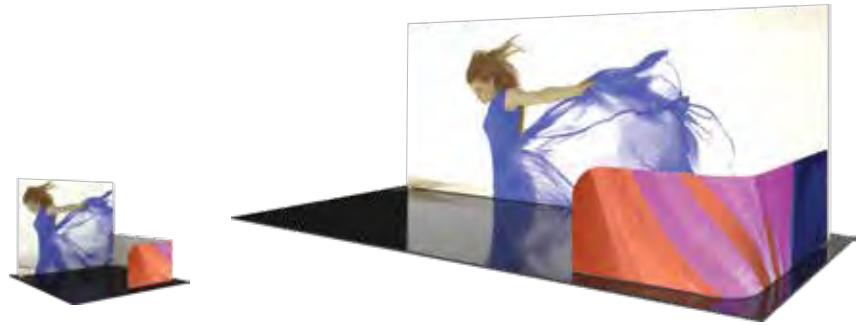
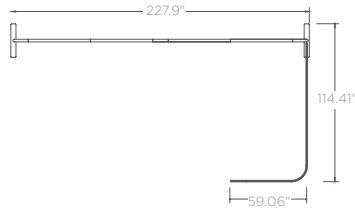

BACKWALL ACCENT 05*

- L-shaped pillowcase fabric graphic attaches to any Formulate Master Straight style backwall
- 48.82"w tabletop included on interior of accent

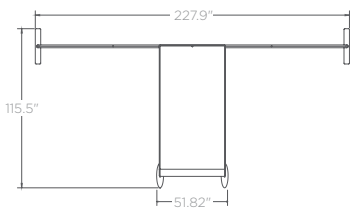

**only for use in peninsula or island tradeshow spaces*

BACKWALL ACCENT 06*

- one straight and one curved panel connect and attach to any Formulate Master Straight style backwall
- 44.94"w x 41.18"h x 14"d laminate counter included on interior of accent provides lockable storage

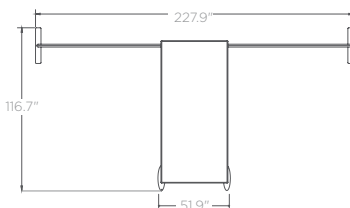

**only for use in peninsula or island tradeshow spaces*

name	code	assembled dimensions
Backwall Accent 04	FMLT-WBWA-04C-L/R	Ⓞ 59.06" w x 35.43" h x 114.41" d
Backwall Accent 05	FMLT-WBWA-05	Ⓞ 51.82" w x 96.87" h x 103.65" d
Backwall Accent 06	FMLT-WBWA-06	Ⓞ 51.9" w x 98.99" h x 107.47" d

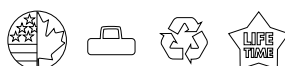

Extend

FORMULATE MASTER HEIGHT EXTENDERS

Add height and additional space for messaging with an 8', 10' or 20' wide Horizontal Curved or Straight Extension Kit! Create stunning 10' tall backwall. Convert your 8' backwall to a 10' tall with a 2' extension kit or buy a 10' tall kit.

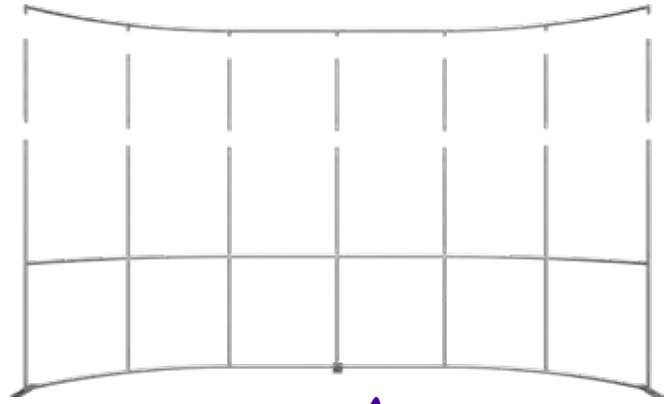

extension kits add two feet!

name	code	assembled dimensions
8' / 10' Straight	FMLT-10FT-EXT-3	Ⓞ 1.37" w x 30.34" h x 1.16" d
8' Horizontal Curved	FMLT-10FT-EXT-3-HC	Ⓞ 1.37" w x 30.34" h x 1.16" d
10' Horizontal Curved	FMLT-10FT-EXT-4-HC	Ⓞ 1.37" w x 30.34" h x 1.16" d
20' Straight	FMLT-10FT-EXT-5	Ⓞ 1.37" w x 30.34" h x 1.16" d
20' Horizontal Curved	FMLT-10FT-EXT-7-HC	Ⓞ 1.37" w x 30.34" h x 1.16" d

Take your exhibit to new heights!

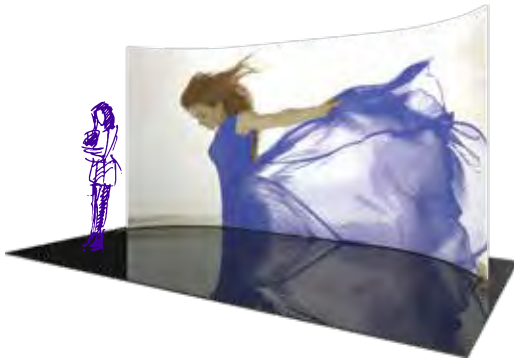

20'W X 10'H KITS
HORIZONTAL & STRAIGHT



10'W X 10'H KITS
HORIZONTAL & STRAIGHT



8'W X 10'H KITS
HORIZONTAL & STRAIGHT

name	code	assembled dimensions
20'w Extended Height Horizontal	FMLT-WH2010	Ⓞ 226.6" w x 120.5" h x 38.38" d
20'w Extended Height Straight	FMLT-WS2010	Ⓞ 234.75" w x 120.5" h x 25.59" d
10'w Horizontal	FMLT-WH1010	Ⓞ 111.84" w x 120.5" h x 22.37" d
10'w Straight	FMLT-WS1010	Ⓞ 116.69" w x 120.5" h x 17.72" d
8'w Horizontal	FMLT-WH0810	Ⓞ 90.12" w x 120.5" h x 17.9" d
8'w Straight	FMLT-WS0810	Ⓞ 92.78" w x 120.5" h x 17.72" d



Vibrant & Dazzling

Formulate® Backlit kits feature a 50mm straight tubular frame, LED curtain lights, which attach at the top and bottom of the frame, and a pillowcase stretch fabric graphic.

FORMULATE BACKLIT KITS

Illuminate and draw attention!



Details

- offered in 3', 5' & 8' widths, all 8'h
- tube frames feature spigot assembly
- LED light curtains attach to the frame
- pillowcase fabric graphic slips over frame
- ships in OCE-2 case

Size Options

name	code	assembled dimensions
3' Backlit kit	FMLT-BL-WS3-01	Ⓞ 34.69" w x 92" h x 25.59" d
5' Backlit kit	FMLT-BL-WS5-01	Ⓞ 61.75" w x 92" h x 26.63" d
8' Backlit kit	FMLT-BL-WS8-01	Ⓞ 90" w x 92" h x 26.63" d

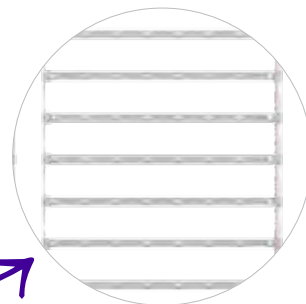

illuminated LED light curtain →



Set up the frame



Add the LED curtain lights

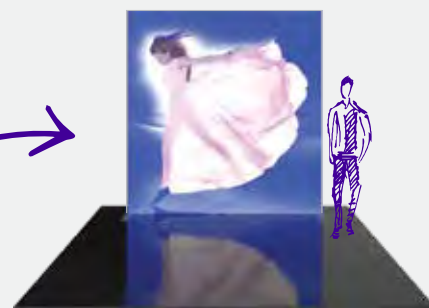

Slip on the fabric graphic



Versatile & Simple

FORMULATE LITE

Details

- portable, versatile 8' by 10' fabric back drop
- converts easily from landscape/horizontal to portrait/vertical configuration
- sturdy, lightweight 30mm aluminum frame with push-buttons
- fabric graphic stretches over the corners of the frame to attach
- comes with carry bag



back view



name	code	assembled dimensions
8'/10' lite display	FMLT-LT-01	Ⓞ 114" w x 92" h x 18.3" d

Portrait or landscape orientation!

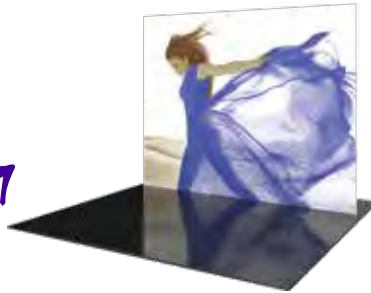

FORMULATE TABLETOP



Details

- straight and vertical curved configurations
- tube frames feature snap button connections
- pillowcase fabric graphic slides over the frame

Size Options

name	code	assembled dimensions
tabletop 01	FMLT-WTT-V01	Ⓞ 61.96" w x 45.36" h x 15.72" d
tabletop 03	FMLT-WTT-V03	Ⓞ 61.96" w x 45.49" h x 25.19" d
tabletop 04	FMLT-WTT-S01	Ⓞ 64.72" w x 46.81" h x 17.71" d



flat feet for support

*Monitors not included.



Formulate® Master | Lite & Tabletop



FORMULATE[®]

designer series



Modern & Sophisticated

Formulate® Designer Series exhibits and structures feature unique stylistic elements, making them modern and sophisticated. Kits couple lightweight aluminum frames with push-fit and zipper pillowcase fabric graphics.



aluminum tube frames are lightweight for easy push-button assembly



aluminum tube frames are lightweight for easy push-button assembly



kits come in OCE-2, OCH or OCL hard shipping cases

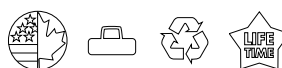

10' Displays

10' FORMULATE DESIGNER SERIES

Formulate® Designer Series 10' displays have unique stylistic features and shapes, are portable and easy to assemble. Aluminum tube frames feature snap-buttons and are coupled with zipper pillowcase fabric graphics. Displays come in portable, wheeled transit cases.



KIT 01*



KIT 02

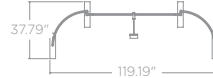

KIT 03



KIT 04



KIT 05



KIT 06*

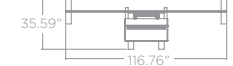

name	code	assembled dimensions
kit 01	FMLT-DS-10-01	Ⓞ 116.3" w x 97.42" h x 50.1" d
kit 02	FMLT-DS-10-02	Ⓞ 119.19" w x 105.41" h x 37.79" d
kit 03	FMLT-DS-10-03	Ⓞ 119.95" w x 98.36" h x 17.7" d
kit 04	FMLT-DS-10-04	Ⓞ 120.01" w x 98.17" h x 41.6" d
kit 05	FMLT-DS-10-05	Ⓞ 116.9" w x 98.27" h x 29.8" d
kit 06	FMLT-DS-10-06	Ⓞ 116.76" w x 98.62" h x 35.59" d



10' Displays

Stand out with unique styling features!



KIT 07*

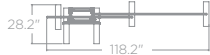

KIT 08*



KIT 09*



KIT 10*



KIT 11*

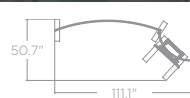

KIT 13



name	code	assembled dimensions
kit 07	FMLT-DS-10-07	⊙ 118.2" w x 98.22" h x 28.2" d
kit 08	FMLT-DS-10-08	⊙ 117.2" w x 97.41" h x 32.5" d
kit 09	FMLT-DS-10-09	⊙ 118.4" w x 98.32" h x 28.5" d
kit 10	FMLT-DS-10-10	⊙ 115.4" w x 98.28" h x 36.5" d
kit 11	FMLT-DS-10-11	⊙ 111" w x 96" h x 50.7" d
kit 13	FMLT-DS-10-13	⊙ 114" w x 90.89" h x 25.59" d

*Monitors not included.

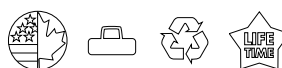

20' Displays

20' FORMULATE DESIGNER SERIES

Formulate® Designer Series 20' & 30' inline exhibits feature unique stylistic elements, making them modern and sophisticated. Formulate Designer Series structures couple lightweight aluminum tube frames with stretch, zipper pillowcase fabric graphics.



KIT 01

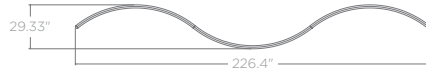

KIT 02



KIT 03



KIT 04



KIT 05*

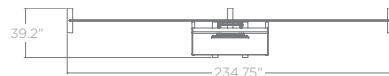

name	code	assembled dimensions
kit 01	FMLT-DS-20-01	226.4" w x 96" h x 29.33" d
kit 02	FMLT-DS-20-02	230" w x 96" h x 40" d
kit 03	FMLT-DS-20-03	227" w x 96" h x 40.75" d
kit 04	FMLT-DS-20-04	234.77" w x 96" h x 17.72" d
kit 05	FMLT-DS-20-05	234.75" w x 98.41" h x 39.2" d



20' Displays

Professional exhibit solutions!



KIT 06*



KIT 07*

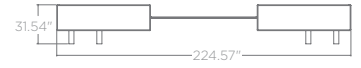

KIT 08*



KIT 12*

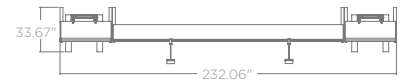

KIT 13*

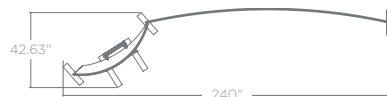

name	code	assembled dimensions
kit 06	FMLT-DS-20-06	Ⓞ 233" w x 96" h x 27.58" d
kit 07	FMLT-DS-20-07	Ⓞ 224.57" w x 96" h x 31.54" d
kit 08	FMLT-DS-20-08	Ⓞ 235.98" w x 96" h x 27.36" d
kit 12	FMLT-DS-20-12	Ⓞ 232.06" w x 96" h x 33.67" d
kit 13	FMLT-DS-20-13	Ⓞ 240" w x 96" h x 42.63" d

Add lights, literature holders and accessories

*Monitors not included.

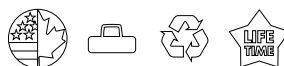

Formulate® Designer Series

30' Displays

30' FORMULATE DESIGNER SERIES

Formulate® Designer Series 30' inline exhibits feature unique stylistic elements, making them modern and sophisticated. Formulate Designer Series structures couple lightweight aluminum tube frames with stretch, zipper pillowcase fabric graphics.



KIT 01



KIT 03



KIT 04



30' Displays

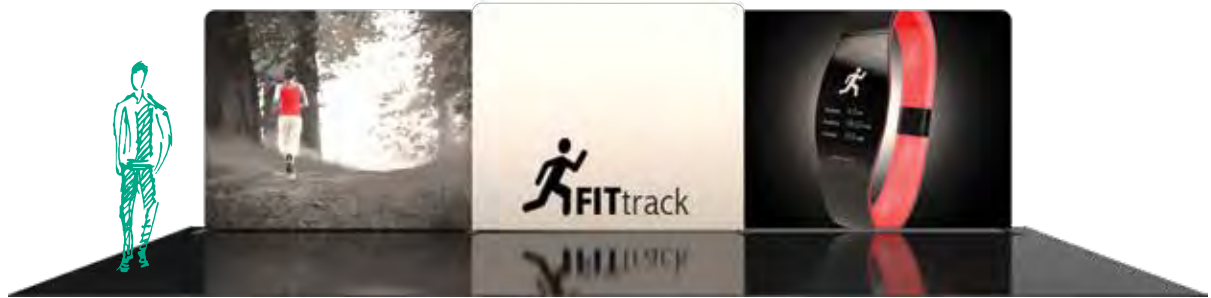

KIT 05



KIT 06

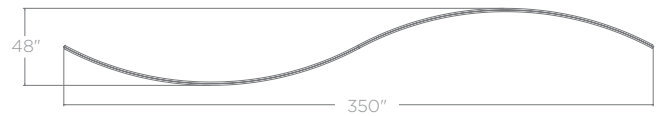

name	code	assembled dimensions
kit 01	FMLT-DS-30-01	Ⓞ 352.82" w x 91.97" h x 25.59" d
kit 03	FMLT-DS-30-03	Ⓞ 350.07" w x 92" h x 36.04" d
kit 04	FMLT-DS-30-04	Ⓞ 350.05" w x 91.84" h x 23.97" d
kit 05	FMLT-DS-30-05	Ⓞ 342.39" w x 96" h x 17.72" d
kit 06	FMLT-DS-30-06	Ⓞ 350" w x 92" h x 48" d

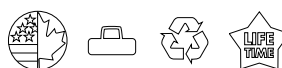



FORMULATE[®] fusion



Dynamic & Commanding

Formulate® Fusion Island Exhibits combine organic and architectural shapes that elevate and accentuate a message and brand to stand out in any trade show or event environment. Fabric combines with form and function, creating organic and unique architectural structures that come with state-of-the-art zipper pillowcase fabric graphics.

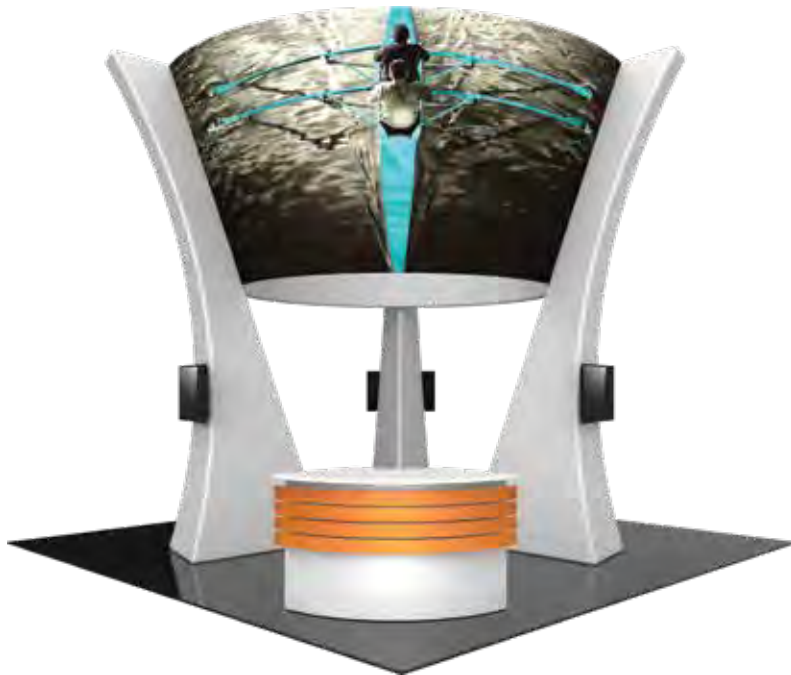

KIT 05 *R*

- fabric covered tower centerpiece, zippered white fabric columns, laminate counter, three monitor mounts* and 1 woodcrate
- combines 50mm aluminum tubing w/ heavy-duty spigot connectors with state-of-the-art zipper pillowcase fabric graphics
- laminate counter with UV printed slat walls provides a welcoming reception area and lockable storage

name	code	assembled dimensions
kit 05	CFAB-K-05	Ⓜ, 240"w x 216"h x 240"d

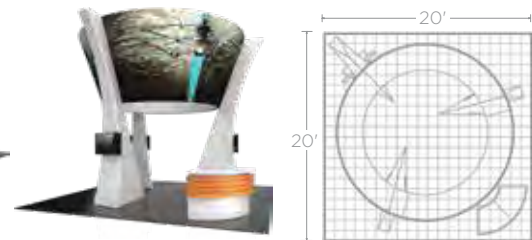

KIT 06

- fabric center tower structure, two side fabric tower structures, rigid graphic accents, CHIP-WALL conference wall, oval counter, five monitor mounts* and 1 woodcrate
- combines 50mm aluminum tubing w/ heavy-duty spigot connector with state-of-the-art zipper pillowcase fabric graphics

name	code	assembled dimensions
kit 05	CFAB-K-05	Ⓜ, 240"w x 216"h x 240"d

*Monitors not included.



20' x 20' Island Exhibit Kits

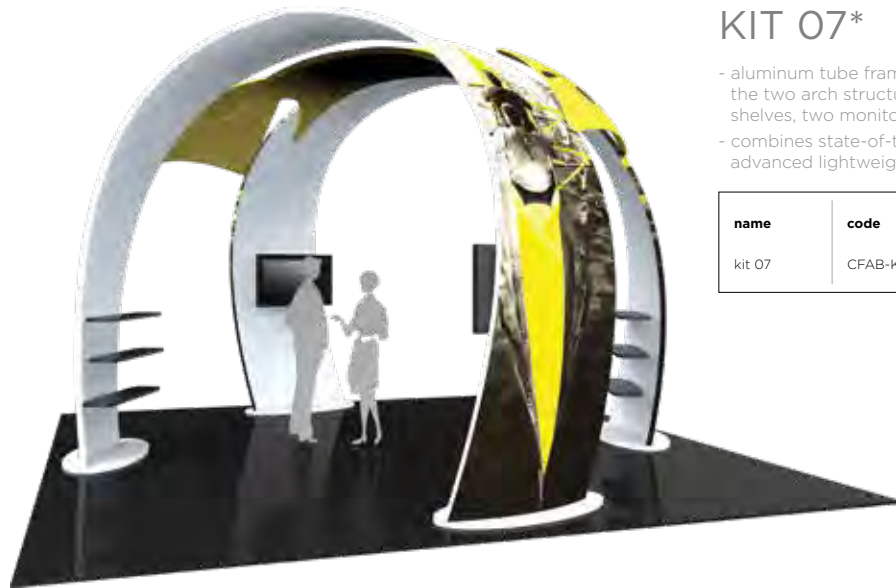

KIT 07*

- aluminum tube frames and zipper pillowcase fabric graphics for the two arch structures, three fabric accents in between arches, six shelves, two monitor mounts* and 1 WOODCRATE-H
- combines state-of-the-art zipper pillowcase fabric graphics with advanced lightweight aluminum tubing

name	code	assembled dimensions
kit 07	CFAB-K-07	@, 240"w x 240"d

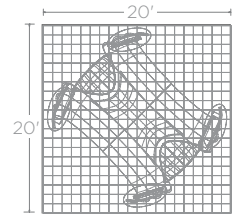

KIT 08

- lightweight, aluminum tube frames and zipper pillowcase fabric graphics for the arch structure and four accent graphics
- structural illuminated accents are 42"w x 105"h and feature three 29.5" illuminated squares each
- tubular/fabric conference room
- oval counter

name	code	assembled dimensions
kit 08	CFAB-K-08	@, 240"w x 240"d

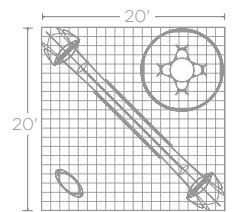

Illuminated squares

20' x 20' Island Exhibit Kits



KIT 09

- combines state-of-the-art zipper pillowcase fabric graphics with advanced lightweight aluminum tubing
- I-shaped structure features a roof-top that extends 18' into exhibit space
- structurally supported by laminated counter and anchors to two accent walls
- two double-sided fabric graphic walls set at a 45 degree angle

name	code	assembled dimensions
kit 09	CFAB-K-09	@, 240" w x 240" d

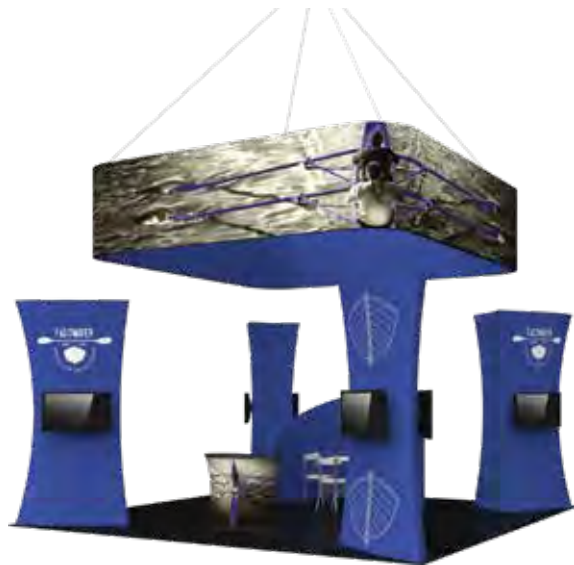
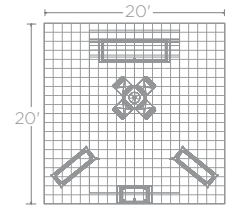

KIT 10*

- combines state-of-the-art zipper pillowcase fabric graphics with advanced lightweight aluminum tubing
- rounded corner 16' square hanging structure; requires rigging
- four 10' tall, 5' wide towers anchor to each corner
- each tower includes two medium monitor mounts* which hold 32"-55" monitors
- semi-private fabric meeting space
- freestanding pillar-shaped fabric counter

name	code	assembled dimensions
kit 10	CFAB-K-10	@, 240" w x 240" d

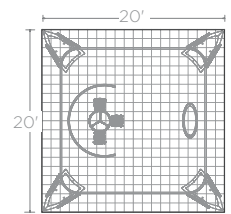

KIT 11*

- trapezoidal-shaped fabric structure rests above four mirrored trapezoidal-shaped corner towers
- four wood counters stand in front of towers
- four towers feature areas for large TV monitors facing the aisles; monitor mounts* included
- two L-shaped fabric dividers for semi-private meetings

name	code	assembled dimensions
kit 11	CFAB-K-11	@, 240" w x 240" d

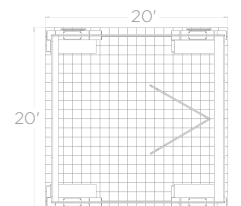

Add a Counter!

Formulate® counters couple lightweight hardware with state-of-the-art printed stretch silicone edge push-fit fabric graphics to create funky and functional reception stands.



PILLAR *R*



HALF MOON



ELLIPSE *R*



BULLET

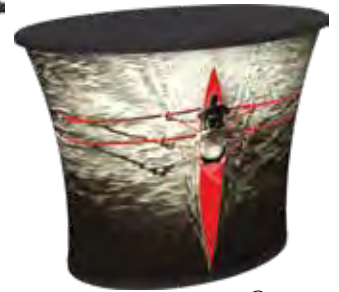

OVAL *R*



BAR 02



BAR 03



BAR 04

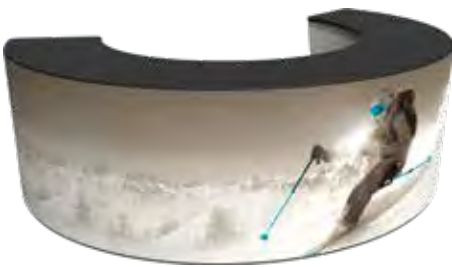

BAR 05



BAR 06



BAR 07

name	code	assembled dimensions
Pillar	W-01-C	Ⓞ 31.5" w x 38" h x 15.75" d
Half moon	W-02-C	Ⓞ 42" w x 38" h x 18" d
Ellipse	W-03-C	Ⓞ 46" w x 38" h x 20" d
Bullet	W-04-C	Ⓞ 46" w x 38" h x 20" d
Oval	W-05-C	Ⓞ 47.28" w x 38" h x 23.75" d

name	code	assembled dimensions
Bar 02	W-06-C-02	Ⓞ 83.5" w x 37.8" h x 34.13" d
Bar 03	W-06-C-03	Ⓞ 110" w x 37.8" h x 24" d
Bar 04	W-06-C-04	Ⓞ 120" w x 37.8" h x 24" d
Bar 05	W-06-C-05	Ⓞ 120" w x 37.8" h x 24" d
Bar 06	W-06-C-06	Ⓞ 120" w x 37.8" h x 24" d
Bar 07	W-06-C-07	Ⓞ 120" w x 37.8" h x 24" d



The industry's choice
FOR CUSTOM DISPLAYS



UNIQUELY DESIGNED | CUSTOM BUILT



FORMULATE®

hanging + architectural structures

Impressive & Striking

Formulate® Hanging Structures and signs are ideal for attracting attention or for use as a focal point at an event or in an interior space by projecting messaging from all angles and drawing the eye to a brand! Available in three collections including Essential (economy), Master (mid-range) and Custom (premium), it is easy to find the hanging sign that fits your need.

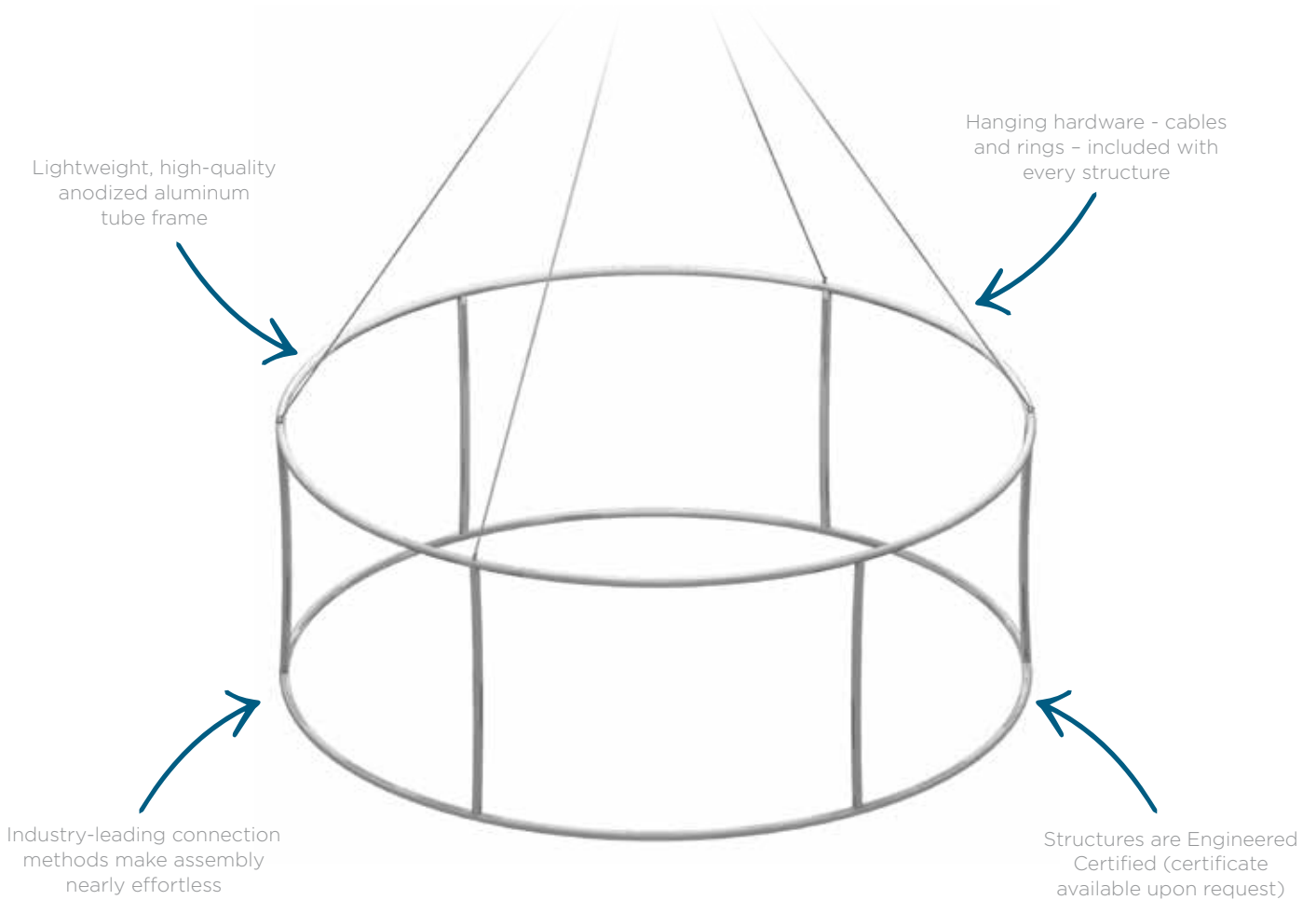

graphic options

BLANK, SINGLE-SIDED, DOUBLE-SIDED AND ZIP-IN
BLANK AND PRINTED BOTTOM PANELS

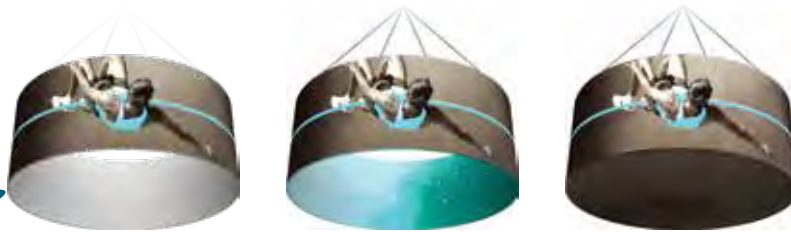

Essential graphics do not include a liner

Fabric printing process provides G7 color-certified, SUPERIOR brilliant and vivid graphics

Tensioned, zippered pillowcase style fabric graphics are hand-sewn in North America, durable and dry-cleanable



Essential Hanging Structures

RING



double-sided
graphic



bottom
graphic

size	code
8' dia. x 2'h	ESS-RNG-0802-2
8' dia. x 3'h	ESS-RNG-0803-2
8' dia. x 4'h	ESS-RNG-0804-2
10' dia. x 2'h	ESS-RNG-1002-2
10' dia. x 3'h	ESS-RNG-1003-2
10' dia. x 4'h	ESS-RNG-1004-2
12' dia. x 2'h	ESS-RNG-1202-2
12' dia. x 3'h	ESS-RNG-1203-2
12' dia. x 4'h	ESS-RNG-1204-2

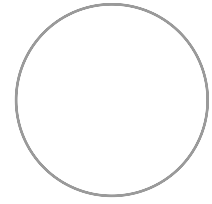

SQUARE



double-sided
graphic



bottom
graphic

size	code
8'w x 2'h	ESS-SQU-0802-2
8'w x 3'h	ESS-SQU-0803-2
8'w x 4'h	ESS-SQU-0804-2
10'w x 2'h	ESS-SQU-1002-2
10'w x 3'h	ESS-SQU-1003-2
10'w x 4'h	ESS-SQU-1004-2
12'w x 2'h	ESS-SQU-1202-2
12'w x 3'h	ESS-SQU-1203-2
12'w x 4'h	ESS-SQU-1204-2

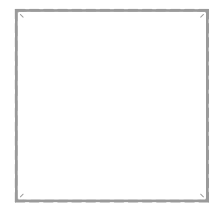

TRIANGLE

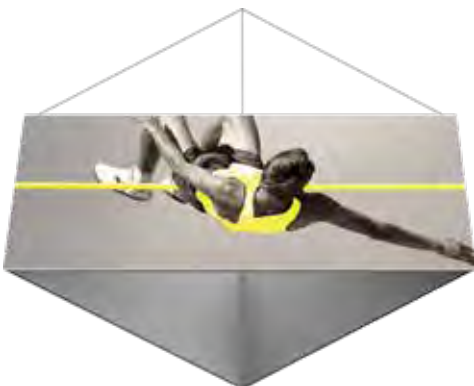

double-sided
graphic



bottom
graphic

size	code
8'w x 2'h	ESS-TRI-0802
8'w x 3'h	ESS-TRI-0803
8'w x 4'h	ESS-TRI-0804
10'w x 2'h	ESS-TRI-1002
10'w x 3'h	ESS-TRI-1003
10'w x 4'h	ESS-TRI-1004
12'w x 2'h	ESS-TRI-1202
12'w x 3'h	ESS-TRI-1203
12'w x 4'h	ESS-TRI-1204

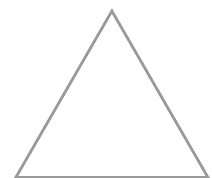

Master Hanging Structures

RING



double-sided graphic



bottom graphic

8' diam. x 2'h/3'h/4'h/5'h/6'h
 10' diam. x 2'h/3'h/4'h/5'h/6'h
 12' diam. x 2'h/3'h/4'h/5'h/6'h
 14' diam. x 2'h/3'h/4'h/5'h/6'h
 16' diam. x 2'h/3'h/4'h/5'h/6'h
 18' diam. x 2'h/3'h/4'h/5'h/6'h
 20' diam. x 2'h/3'h/4'h/5'h/6'h

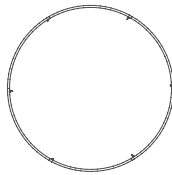

CUBE

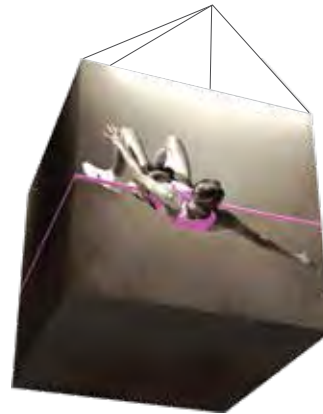

illuminated cube

3'w x 3'h
 4'w x 4'h
 6'w x 6'h
 8'w x 8'h
 10'w x 10'h

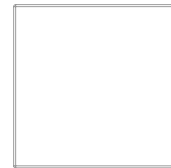

*illuminated cube also available

SQUARE



double-sided graphic



bottom graphic

8'w x 2'h/3'h/4'h/5'h/6'h
 10'w x 2'h/3'h/4'h/5'h/6'h
 12'w x 2'h/3'h/4'h/5'h/6'h
 14'w x 2'h/3'h/4'h/5'h/6'h
 16'w x 2'h/3'h/4'h/5'h/6'h
 18'w x 2'h/3'h/4'h/5'h/6'h
 20'w x 2'h/3'h/4'h/5'h/6'h

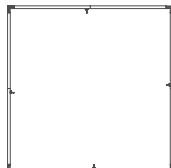

TAPERED SQUARE

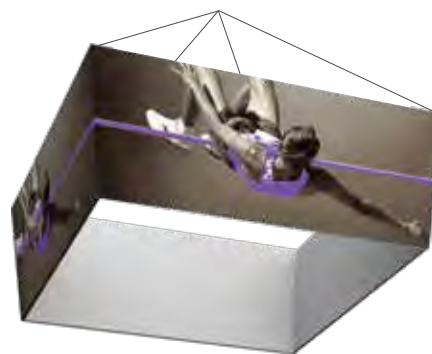

double-sided graphic

8'w x 2'h/3'h/4'h/5'h/6'h
 10'w x 2'h/3'h/4'h/5'h/6'h
 12'w x 2'h/3'h/4'h/5'h/6'h
 14'w x 2'h/3'h/4'h/5'h/6'h
 16'w x 2'h/3'h/4'h/5'h/6'h
 18'w x 2'h/3'h/4'h/5'h/6'h
 20'w x 2'h/3'h/4'h/5'h/6'h

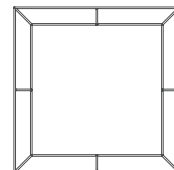

Master Hanging Structures

TRIANGLE



double-sided graphic



bottom graphic

8'w x 2'h/3'h/4'h/5'h/6'h
10'w x 2'h/3'h/4'h/5'h/6'h
12'w x 2'h/3'h/4'h/5'h/6'h
14'w x 2'h/3'h/4'h/5'h/6'h
16'w x 2'h/3'h/4'h/5'h/6'h
18'w x 2'h/3'h/4'h/5'h/6'h
20'w x 2'h/3'h/4'h/5'h/6'h

CONVEX TRIANGLE (SHIELD)



double-sided graphic

8'w x 2'h/3'h/4'h/5'h/6'h
10'w x 2'h/3'h/4'h/5'h/6'h
12'w x 2'h/3'h/4'h/5'h/6'h
14'w x 2'h/3'h/4'h/5'h/6'h
16'w x 2'h/3'h/4'h/5'h/6'h
18'w x 2'h/3'h/4'h/5'h/6'h
20'w x 2'h/3'h/4'h/5'h/6'h

PINWHEEL

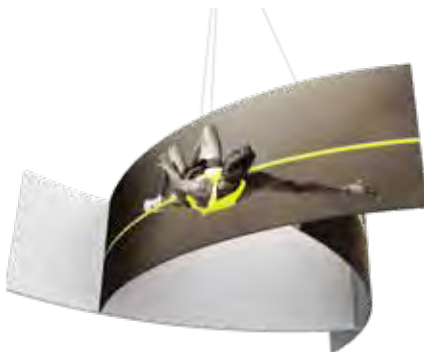

double-sided graphic

8'w x 2'h/3'h/4'h/5'h/6'h
10'w x 2'h/3'h/4'h/5'h/6'h
12'w x 2'h/3'h/4'h/5'h/6'h
14'w x 2'h/3'h/4'h/5'h/6'h
16'w x 2'h/3'h/4'h/5'h/6'h
18'w x 2'h/3'h/4'h/5'h/6'h
20'w x 2'h/3'h/4'h/5'h/6'h

FOOTBALL

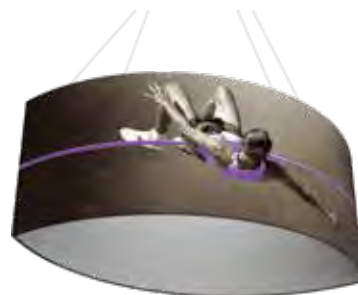

double-sided graphic

8'w x 2'h/3'h/4'h/5'h/6'h
10'w x 2'h/3'h/4'h/5'h/6'h
12'w x 2'h/3'h/4'h/5'h/6'h
14'w x 2'h/3'h/4'h/5'h/6'h
16'w x 2'h/3'h/4'h/5'h/6'h
18'w x 2'h/3'h/4'h/5'h/6'h
20'w x 2'h/3'h/4'h/5'h/6'h

CURVE



8'w x 2'h/3'h/4'h/5'h/6'h
10'w x 2'h/3'h/4'h/5'h/6'h
12'w x 2'h/3'h/4'h/5'h/6'h
14'w x 2'h/3'h/4'h/5'h/6'h
16'w x 2'h/3'h/4'h/5'h/6'h
18'w x 2'h/3'h/4'h/5'h/6'h
20'w x 2'h/3'h/4'h/5'h/6'h

PANEL



8'w x 2'h/3'h/4'h/5'h/6'h
10'w x 2'h/3'h/4'h/5'h/6'h
12'w x 2'h/3'h/4'h/5'h/6'h
14'w x 2'h/3'h/4'h/5'h/6'h
16'w x 2'h/3'h/4'h/5'h/6'h
18'w x 2'h/3'h/4'h/5'h/6'h
20'w x 2'h/3'h/4'h/5'h/6'h



Master Hanging Structures

RECTANGLE



double-sided graphic

8'w x 2'h/3'h/4'h/5'h/6'h
 10'w x 2'h/3'h/4'h/5'h/6'h
 12'w x 2'h/3'h/4'h/5'h/6'h
 14'w x 2'h/3'h/4'h/5'h/6'h
 16'w x 2'h/3'h/4'h/5'h/6'h
 18'w x 2'h/3'h/4'h/5'h/6'h
 20'w x 2'h/3'h/4'h/5'h/6'h

FOUR-SIDED PYRAMID

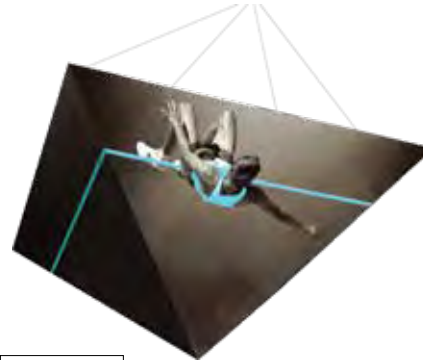

10'w x 5'h
 12'w x 6'h
 16'w x 8'h
 20'w x 10'h

RECTANGLE

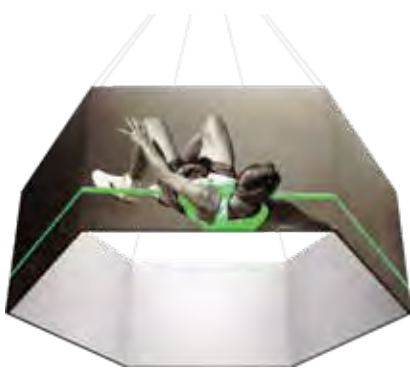

double-sided graphic

8'w x 2'h/3'h/4'h/5'h/6'h
 10'w x 2'h/3'h/4'h/5'h/6'h
 12'w x 2'h/3'h/4'h/5'h/6'h
 14'w x 2'h/3'h/4'h/5'h/6'h
 16'w x 2'h/3'h/4'h/5'h/6'h

DISC

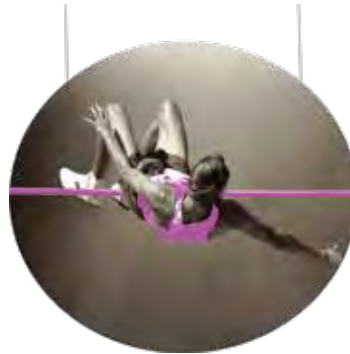

bottom graphic

8' diameter
 10' diameter
 12' diameter
 14' diameter
 16' diameter
 18' diameter
 20' diameter

S-CURVE



8'w x 2'h/3'h/4'h/5'h/6'h
 10'w x 2'h/3'h/4'h/5'h/6'h
 12'w x 2'h/3'h/4'h/5'h/6'h
 14'w x 2'h/3'h/4'h/5'h/6'h
 16'w x 2'h/3'h/4'h/5'h/6'h
 18'w x 2'h/3'h/4'h/5'h/6'h
 20'w x 2'h/3'h/4'h/5'h/6'h

Certain shapes and sizes available for rent!



Funnels

Versatile Formulate® Funnels transform any environment through form, fabric and lighting. Formulate Funnels have an hourglass shape, come in 20', 16' and 12' heights and have 8' diameters at the top and 3 1/2' diameters at the bottom. Funnels feature a heavy-duty, wooden base and silver brushed coated truss interior to create a dynamic, towering structure that commands attention. Fabric graphics feature a zipper at the top and a silicone edge at the bottom for easy assembly.

FORMULATE FUNNELS

size	name	code	assembled dimensions
20'h	Funnel 01	FUN-01	Ⓞ 98.5"w x 237"h x 98.5"d
16'h	Funnel 02	FUN-02	Ⓞ 98.5"w x 188.41"h x 98.5"d
12'h	Funnel 03	FUN-03	Ⓞ 98.5"w x 140.97"h x 98.5"d
16'h	Funnel 04	FUN-04	Ⓞ 98.5"w x 188.42"h



20' FUNNEL



16' FUNNEL *R*



12' FUNNEL



16' FUNNEL



Silicone edge at the bottom of the graphic for easy assembly



Towers

Mix and match the Formulate® line of towers to add architecture and drama to any event or interior space. Cylinder-shaped, Rectangular-shaped and Shield-shaped towers come in 12', 10' and 8' heights and 3' square/diameters at the tops and bottoms. They combine the latest developments in fabric printed technology with aluminum tube frames to add dimension, décor and sculpture to any event, stage set, tradeshow booth or interior space. Custom sizes also available.

Custom sizes available!

FORMULATE TOWERS

size	name	code	assembled dimensions
3' x 12'	Four Sided Tower 01	COL-01	Ⓞ 36" w x 144" h x 36" d
3' x 10'	Four Sided Tower 02	COL-02	Ⓞ 36" w x 120" h x 36" d
3' x 8'	Four Sided Tower 03	COL-03	Ⓞ 36" w x 96" h x 36" d
3' x 12'	Backlit Four Sided Tower 01	COL-01-BL	Ⓞ 36" w x 144" h x 36" d
3' x 10'	Backlit Four Sided Tower 02	COL-02-BL	Ⓞ 36" w x 120" h x 36" d
3' x 8'	Backlit Four Sided Tower 03	COL-03-BL	Ⓞ 36" w x 96" h x 36" d



12' FOUR
SIDED TOWER



10' FOUR
SIDED TOWER *R*



8' FOUR
SIDED TOWER



12' BACKLIT
FOUR SIDED
TOWER



10' BACKLIT
FOUR SIDED
TOWER



8' BACKLIT
FOUR SIDED
TOWER

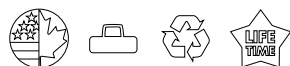

Towers

Mix and match the Formulate line of towers to add architecture and drama to any event or interior space. Cylinder, Rectangular and Shield-shaped towers come in 12', 10' and 8' heights and 3' square/diameters at the tops and bottoms.

size	name	code	assembled dimensions
10'h	Tower 02	TOWER-02	Ⓞ 60.15" w x 120" h x 54.48" d
12'h	Shield Tower 03	SHD-TOWER-03	Ⓞ 35.92" w x 144" h x 59.42" d
10'h	Shield Tower 02	SHD-TOWER-02	Ⓞ 36" w x 120" h x 59.5" d
8'h	Shield Tower 01	SHD-TOWER-01	Ⓞ 35.92" w x 96" h x 59.42" d
12'h	Cylinder Tower 01	CYL-01	Ⓞ 36" w x 144" h x 36" d
10'h	Cylinder Tower 02	CYL-02	Ⓞ 36" w x 120" h x 36" d
8'h	Cylinder Tower 03	CYL-03	Ⓞ 36" w x 9" h x 36" d



10' TOWER

Also available without shelving



12' SHIELD TOWER



10' SHIELD TOWER



8' SHIELD TOWER



12' CYLINDER TOWER



10' CYLINDER TOWER



8' CYLINDER TOWER



Backlit Ring Tower

The Formulate® Backlit Ring Tower is a commanding structure that will help your message and brand stand out. This glowing structure stands just over 14ft tall and is approximately 10ft wide.

Details

- state-of-the-art 30mm aluminum tube frame with snap button assembly
- easy to store and ship
- commanding & impactful illuminated display
- includes: one ring frame, one platform frame, one tower frame, two dye-sublimated zipper pillowcase graphics, five 16-strip curtain lights, and two 20-strip curtain lights
- lights attach and stay taught on frame with bungee cords
- assembly requires a minimum of two people
- recommend 8' or 10' ladder for installation & dismantle
- boxes fit into SCRATE, which is an optional upgrade
- lifetime hardware warranty against manufacturer defects

name	code	assembled dimensions
Backlit Ring Tower	RNG-TOW-BL	119.5" w x 172" h x 119.5" d

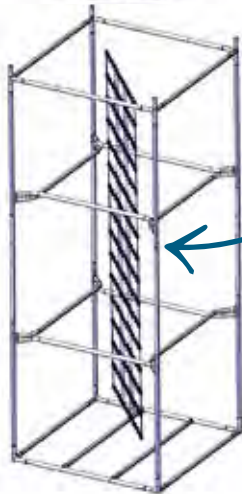
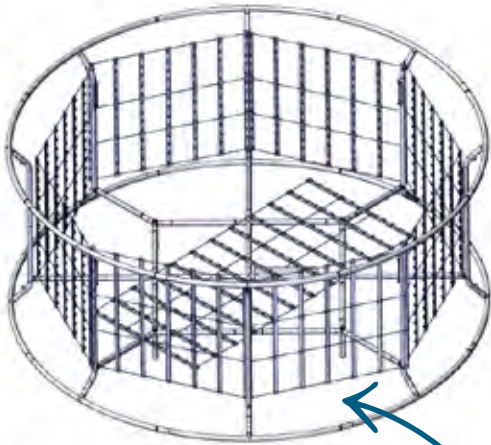

LED light curtains easily attach to the frame and make the structure glow from within

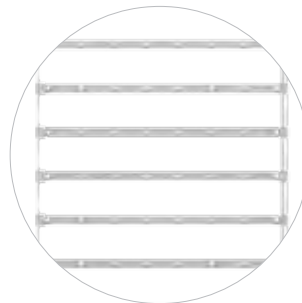

Arches

Formulate® Arches add architecture and design to any event or interior space! Easily create and define a stunning entryway, focal point or stage set at your next tradeshow or event. Custom sizes also available.

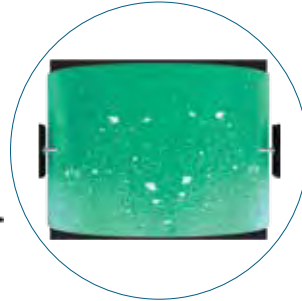
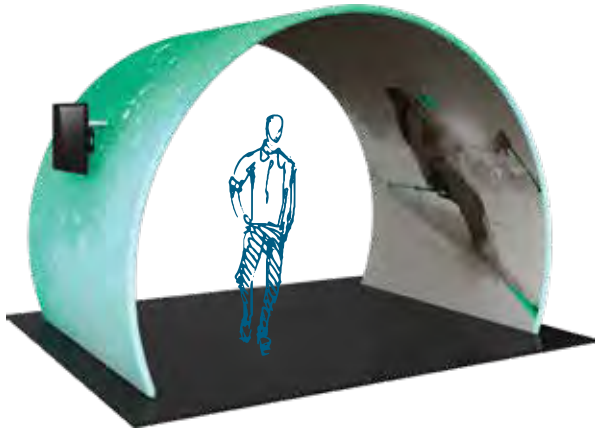

overhead perspective

ARCH 01 12'

- 8' tall, spans 11 1/2' wide, 8' deep at the bases
- two monitor mounts* are included, externally facing, adding a bonus opportunity to display messaging & branding
- shown in a 12' space

name	code	assembled dimensions
Arch 01	ARCH-01	Ⓞ, 136.56" w x 95.31" h x 92" d

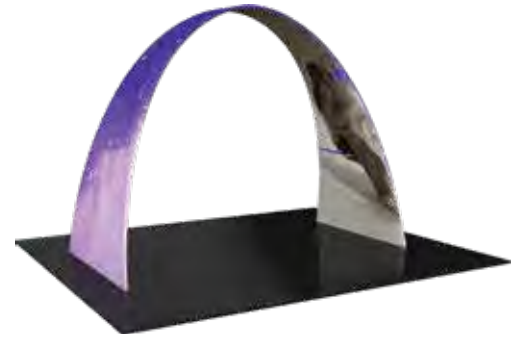

ARCH 02 10'

- 7 2/3' tall, spans 9 1/2' wide and is nearly 5' deep at the bases
- shown in a 10' space

name	code	assembled dimensions
Arch 02	ARCH-02	Ⓞ, 114" w x 91.83" h x 58" d



ARCH 03 20'

- 11 1/2' tall, spans 19 1/2' wide and is 8' deep at the bases
- fits perfectly in a 20' x 20' island space - shown in a 20' space

name	code	assembled dimensions
Arch 03	ARCH-03	Ⓞ, 229.58" w x 136" h x 96" d

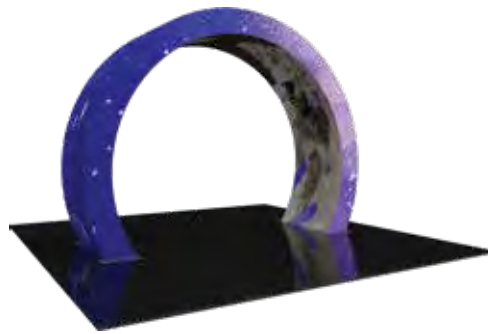

ARCH 06 17'

- 12 1/2' tall, spans 17' wide and 5'4" deep
- three dimensional shape for added impact

name	code	assembled dimensions
Arch 06	ARCH-06	Ⓞ, 285.19" w x 140.37" h x 153.43" d



ARCH 07 10'

- 7 1/2' tall, spans 10' wide and 4' 7/8" deep

name	code	assembled dimensions
Arch 07	ARCH-07	Ⓞ, 121" w x 90.5" h x 58.5" d

Conference Walls & Rooms

Ergonomically designed, Formulate® walls combine the latest developments in fabric printed technology with gently curved 50mm aluminum frames to create private, cozy and stylish conference areas within any space.



C-SHAPED WALL

- 7' tall at 7'4" diameter

name	code	assembled dimensions
C-shaped wall	C-WALL	@ 89.59" w x 84" h x 60" d



CONFERENCE WALL*

- features two fabric walls and a sheer fabric canopy
- large enough to house a small table and four chairs

name	code	assembled dimensions
Conference wall	C-WALL-02	@ 108" w x 102" h



CHIP-SHAPED WALL* *R*

- potato chip shaped structure that stands 8' tall and is 9'3" wide

name	code	assembled dimensions
Chip-shaped wall	CHIP-WALL	@ 111" w x 96" h x 61.9" d



CHIP-SHAPED WALL*

- curved conference room divider that stands 6'4" tall and is 9'5" wide

name	code	assembled dimensions
Chip-shaped wall 02	CHIP-WALL-02	@ 111" w x 75.6" h

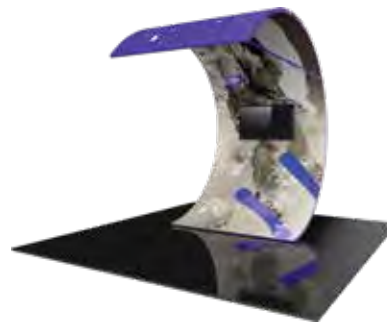

SURF*

- C-shaped multimedia display that stands 11'4" tall with a width of 7'7"
- curved shape sustained by supporting legs
- monitor mounts included

name	code	assembled dimensions
Surf video wall	SURF-WALL	@ 92" w x 136.69" h x 120.93" d

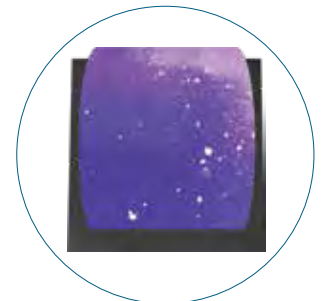

overhead perspective



TREE HOUSE *R*

- cylinder-shaped space perfect for meetings, graphical displays, projected presentations, a theater setting
- 15' in diameter, 8' tall and features two 7' tall doorways, encouraging traffic flow

name	code	assembled dimensions
Tree house room	TREEHOUSE-RM	@ 180" w x 96" h





HYBRID PRO™

modular



Impactful & Sophisticated

Hybrid Pro™ Modular exhibits are versatile, striking and reconfigurable displays that combine quality aluminum extrusion frames with vibrant push-fit fabric graphics to create sophisticated exhibits perfect for tradeshow and event applications.



Details

- uniquely designed exhibit backwalls and counters feature heavy-duty aluminum frames and push-fit fabric graphics
- accents include tables, monitor mounts, interior LED lighting and more
- 10' x 20' Inline displays reconfigure to 10'x10' versions, increasing the value and investment
- counters can be mixed and matched, and used for non-tradeshow applications
- frames and graphics are quality manufactured in North America

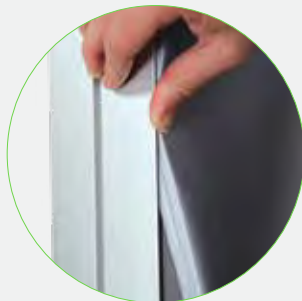

easy-to-apply push-fit fabric graphics



add a counter - the perfect addition to any Hybrid Pro backwall display



10' Exhibit Kits



KIT 01

R



KIT 02

R



KIT 03

R



KIT 04

R



KIT 05

R



KIT 06

R



Counters featured on p. 118-119

Hybrid Pro counter tops are available in your choice of four color options



silver black mahogany natural

name	code	assembled dimensions
Kit 01	HP-K-01	Ⓞ 111.25" w x 94.75" h x 34.75" d
Kit 02	HP-K-02	Ⓞ 115.63" w x 94.5" h x 42.88" d
Kit 03	HP-K-03	Ⓞ 111.63" w x 94.75" h x 30.38" d
Kit 04	HP-K-04	Ⓞ 114.13" w x 94.5" h x 33.25" d
Kit 05	HP-K-05	Ⓞ 114.13" w x 94.5" h x 19.63" d
Kit 06	HP-K-06	Ⓞ 118.63" w x 94.75" h x 29.5" d

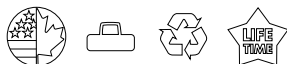

10' Exhibit Kits

slot wall

KIT 07

R



KIT 08

R



KIT 21



KIT 24



KIT 27



KIT 30



easy-to-apply push-fit fabric graphics

name	code	assembled dimensions
Kit 07	HP-K-01	⊙ 115.25" w x 95.63" h x 79.25" d
Kit 08	HP-K-02	⊙ 114.13" w x 94.5" h x 19.63" d
Kit 21	HP-K-03	⊙ 118.55" w x 95.45" h x 1.75" d
Kit 24	HP-K-04	⊙ 114.76" w x 95.45" h x 70.2" d
Kit 27	HP-K-05	⊙ 116.14" w x 94.45" h x 33.17" d
Kit 30	HP-K-06	⊙ 118.36" w x 95.45" h x 30.2" d

*Monitors not included.



Hybrid Pro™ Modular

20' Exhibit Kits

illuminated walls



KIT 09
R



KIT 10
R

illuminated wall



KIT 11
R



KIT 13
R



KIT 14
R



KIT 15
R



Hybrid Pro counter tops are available in your choice of four color options



silver black mahogany natural



20' Exhibit Kits

KIT 16
R



KIT 22



KIT 25



KIT 28



KIT 31



name	code	assembled dimensions
Kit 09	HP-K-09	⊕ 228.38" w x 94.75" h x 40.13" d
Kit 10	HP-K-10	⊕ 229.25" w x 94.5" h x 42.88" d
Kit 11	HP-K-11	⊕ 222.75" w x 94.75" h x 19.63" d
Kit 13	HP-K-13	⊕ 232.25" w x 94.5" h x 19.63" d
Kit 14	HP-K-14	⊕ 225.13" w x 94.75" h x 41.69" d
Kit 15	HP-K-15	⊕ 233.38" w x 95.63" h x 78.75" d
Kit 16	HP-K-16	⊕ 232.38" w x 94.5" h x 37.5" d
Kit 22	HP-K-22	⊕ 234.69" w x 95.45" h x 1.75" d
Kit 25	HP-K-25	⊕ 221.19" w x 95.45" h x 68.92" d
Kit 28	HP-K-28	⊕ 231.69" w x 95.45" h x 32.48" d
Kit 31	HP-K-31	⊕ 236.47" w x 95.45" h x 33.58" d

*Monitors not included.



Hybrid Pro™ Modular

20'x20' Island Exhibit Kits

Hybrid Pro™ Modular island exhibit kits provide an unparalleled dynamic that elevates and accentuates a message and brand, but also maximizes the return on tradeshow investment. Hybrid Pro Modular offers a collection of 20' x 20' exhibit kits and custom solutions. Heavy-duty aluminum extrusions are coupled with vibrant graphics to create sophisticated, commanding and unforgettable island spaces. All displays and graphics are made in North America.



No rigging required!

KIT 17 / 17B*



- 15'9" tall 20' x 20' island display
- heavy-duty aluminum extrusion tower frame couples with seamless push-fit SEG fabric graphics
- kit 17B does not include the standalone foreground kiosk



HP-K-17
Overhead



HP-K-17
Isometric



HP-K-17-B
Overhead



HP-K-17-B
Isometric



KIT 18*



- 11'10" tall square shaped island display
- square-shaped, heavy-duty aluminum extrusion frame coupled with seamless push-fit SEG fabric graphics
- accessible storage and locking door



Isometric View

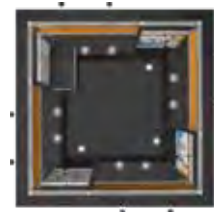

Overhead View

name	code	assembled dimensions
Kit 17 Kit 17B	HP-K-17 HP-K-17-B	Ⓞ, 240"w x 189"h x 240"d
Kit 18	HP-K-18	Ⓞ, 153.5"w x 141.75"h x 153.5"d



20'x20' Island Exhibit Kits

Impressive, turnkey island exhibit solutions!



KIT 19*

R

- 15'9" tall island display
- heavy-duty aluminum extrusion frame coupled with seamless push-fit SEG fabric graphics
- features two semi-private meeting alcoves with curved frosted plex infills
- storage room features white laminate panels, locking door & monitor mount



Isometric View

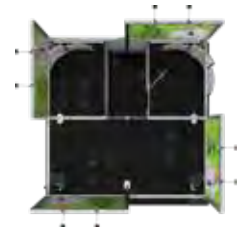

Overhead View



No rigging! Freight ship!

KIT 20*

R

- stands approximately 14' tall and features a 12'd x 4'h circular ring structure, laminated wood structures and fabric graphic walls
- single-sided dye-sublimated push-fit fabric graphics with hook & loop on perimeter
- four internally facing shelving areas feature three 24" x 24" shelves each



Isometric View



Overhead View

name	code	assembled dimensions
Kit 19	HP-K-19	235.62" w x 189" h x 200.75" d
Kit 20	HP-K-20	212.87" w x 163.37" h x 212.37" d

*Monitors not included.



Hybrid Pro™ Modular

20'x20' Island Exhibit Kits

No rigging required!



KIT 23*

- 14'4" tall 20' x 20' island display
- 14'w x 2'h top rectangular structure is tubular & features pillowcase fabric graphics
- centered rectangular structure features power stretch push-fit fabric graphic
- aluminum extrusion tower and display walls
- 6.5'w x 8'h walls feature shelves, monitor mounts & seamless push-fit fabric graphics



Isometric View



Overhead View



KIT 26*

- 12'6" tall 20' x 20' island display
- 12'w x 3'h top rectangular structure is tubular & features pillowcase fabric graphics
- 8'h walls feature a monitor mount, closet area & seamless push-fit fabric graphics



Isometric View



Overhead View

name	code	assembled dimensions
Kit 23	HP-K-23	Ⓞ 244.33" w x 171.5" h x 168" d
Kit 26	HP-K-26	Ⓞ 146.22" w x 143.41" h x 146.22" d



20'x20' Island Exhibit Kits

Add counters for reception & extra storage space!



KIT 29

- 12'4" tall 20' x 20' island display
- 13'w x 3'h x 4'd header structure is tubular & features pillowcase fabric graphics
- 8'w x 8'h tower/closet features a shelving & seamless push-fit fabric graphics
- 4'w x 8'h kiosks feature Modulate magnetic tube frame walls & shelving



Isometric View



Overhead View



No rigging required!

KIT 32*

- 11'5" tall 20' x 20' island display
- 19'w x 3'h x 12'd oval header structure is tubular & features pillowcase fabric graphics
- 5'w x 8'h closet features accessible storage, shelving & seamless push-fit fabric graphics
- two, 2.5'w x 8'h walls feature shelves perfect for putting products on display
- 5'w x 8'h wall features monitor mount for presentations & demonstrations

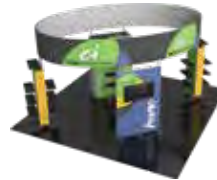

Isometric View



Overhead View

name	code	assembled dimensions
Kit 29	HP-K-29	ⓐ 279.19" w x 149.96" h x 53.54" d
Kit 32	HP-K-32	ⓐ 279.19" w x 149.96" h x 53.54" d

*Monitors not included.



Hybrid Pro™ Modular

Add a Counter!



COUNTER 01

- white laminate cabinet with fabric graphic on the front, opaque or backlit



COUNTER 12

- white laminate cabinet with vinyl graphic (-01-B) or fabric graphic (-12), available opaque or backlit



COUNTER 02

- white laminate cabinet with fabric graphic on the front, opaque or backlit



COUNTER 09

- white laminate cabinet with UV graphic on the front, opaque or backlit



COUNTER 10

- white laminate cabinet with UV graphic on the front, opaque or backlit

Select Hybrid Pro counter bodies come in white; other colors available with additional lead time



dove grey

black

designer white

fusion maple

name	code	assembled dimensions
Counter 01	HPC-01	Ⓞ 39.38" w x 39.38" h x 17.75" d
Counter 12	HPC-01-B HPC-12	Ⓞ 21.9" w x 38.24" h x 17.72" d
Counter 02	HPC-02	Ⓞ 70.88" w x 39.38" h x 23.63" d
Counter 09	REC-42	Ⓞ 46" w x 37.5" h x 23" d
Counter 10	REC-53	Ⓞ 64" w x 37.5" h x 30" d

Add a Counter!



COUNTER 03

- 39.38" w x 36.63" h x 15.75" d
- white laminate panel cabinet with UV graphic on the front and laminate top



COUNTER 04

- 74.6" w x 36.61" h x 26.16" d
- white laminate panel cabinet with UV graphic on the front and laminate top



COUNTER 11

- 71.06" w x 36.61" h x 32.72" d
- white laminate panel cabinet with UV graphic on the front and laminate top



COUNTER 13

- 47.25" w x 39.37" h x 23.15" d
- 4ft wide, open white laminate counter
- vinyl can be applied to add color



COUNTER 14

- 59.06" w x 39.37" h x 23.15" d
- 5ft wide, open white laminate counter
- vinyl can be applied to add color

Select Hybrid Pro counter tops are available in your choice of four color options



silver black mahogany natural

name	code	assembled dimensions
Counter 03	HPC-03	Ⓞ 39.38" w x 36.63" h x 15.75" d
Counter 04	HPC-04	Ⓞ 74.6" w x 36.61" h x 26.16" d
Counter 11	RCK-06	Ⓞ 71.06" w x 36.61" h x 32.72" d
Counter 13	HPC-13	Ⓞ 47.25" w x 39.37" h x 23.15" d
Counter 14	HPC-14	Ⓞ 59.06" w x 39.37" h x 23.15" d





VECTOR FRAME™

geometric displays

Contemporary & Impressive

Make a strong and lasting impression in an interior environment or at your next trade show or event with Vector Frame™ Modular Displays and structures. Wow any audience with the clean, contemporary appearance of this system.



Details

- innovative and displays will captivate and WOW your audience
- geometric shaped backwalls, banners, exhibit kits, counters and light boxes feature durable, easy-to-assemble aluminum extrusion frames and push-fit fabric graphics
- can be reconfigured and customized to create completely tailored solutions

illuminate your backwall

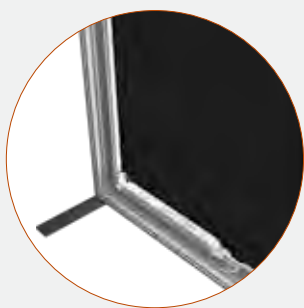

aluminum extrusion frame easy to assemble



easy-to-apply push-fit fabric graphics



add a counter - the perfect addition to any Vector Frame display

Eye-catching Light Boxes

VECTOR FRAME ESSENTIAL LIGHT BOXES

These sophisticated light boxes have superior aesthetic and assembly qualities and require no tools for assembly! Simply slide each frame piece together, apply the push-fit fabric graphics and plug in. LED lighting comes pre-attached to the frame and swivel lock feet give added stability. These displays are ideal for retail, interior and event environments.



SQURE 01



frame easily assembles

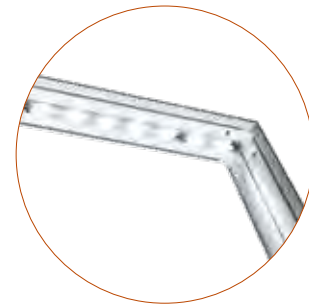

lights come pre-attached to the frame

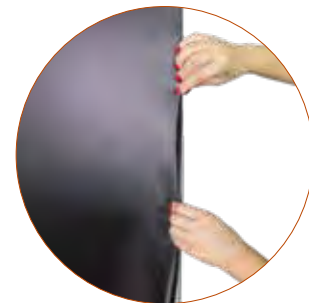

easy-to-apply push-fit graphics

Details

- light boxes feature sleek, scratch-resistant white aluminum frames with swivel feet
- LED light strips are pre-attached to the top and bottom of the frame
- includes choice of single or double-sided push-fit INTENSITY backlit fabric graphic
- includes 6' power cord
- comes with reusable cardboard box with handle
- easy to assemble

*perfect for retail stores, airports,
restaurants and more!*

Size Options

name	code	graphic width	graphic height	assembled dimensions
Rectangle 01	VF-ESS-LB-R-01	33.88"	71.88"	Ⓞ 36" w x 72.75" h x 15.75" d
Rectangle 02	VF-ESS-LB-R-02	35.88"	95.88"	Ⓞ 36" w x 96.75" h x 15.75" d
Rectangle 03	VF-ESS-LB-R-03	47.88"	71.88"	Ⓞ 48" w x 72.75" h x 15.75" d
Rectangle 04	VF-ESS-LB-R-04	47.88"	95.88"	Ⓞ 48" w x 96.75" h x 15.75" d
Square 01	VF-ESS-LB-S-01	95.88"	95.88"	Ⓞ 96" w x 96.75" h x 15.75" d
Rectangle 05	VF-ESS-LB-R-05	119.88"	95.88"	Ⓞ 120" w x 96.75" h x 15.75" d
Rectangle 06	VF-ESS-LB-R-06	244.13"	100.5"	Ⓞ 240.5" w x 97" h x 15.75" d



Illuminating & Striking

VECTOR FRAME MASTER LIGHT BOXES

Details

- banners feature 2" aluminum extrusion frames and push-fit silicone-edge fabric graphics
- light boxes feature 4" aluminum extrusion frames with new & improved LED edge lighting & push-fit INTENSITY backlit fabric graphics
- single and double-sided graphics offered
- come in OCE, OCS, OCH or OCL hard shipping cases

Size Options

name	code	graphic width	graphic height	assembled dimensions
Rectangle 01	VF-R-01 VF-LB-R-01	35.31"	47.125"	ⓐ, 36.3"w x 47.49"h x 19.69"d
Rectangle 02	VF-R-02 VF-LB-R-02	35.31"	70.75"	ⓐ, 36.3"w x 71.12"h x 19.69"d
Rectangle 03	VF-R-03 VF-LB-R-03	47.125"	70.75"	ⓐ, 48.11"w x 71.12"h x 19.69"d
Rectangle 04	VF-R-04 VF-LB-R-04	47.125"	94.375"	ⓐ, 48.11"w x 94.74"h x 19.69"d
Rectangle 05	VF-R-05 VF-LB-R-05	118"	94.375"	ⓐ, 118.98"w x 94.74"h x 19.69"d
Rectangle 06	VF-R-06 VF-LB-R-06	35.68"	94.38"	ⓐ, 35.7"w x 94.74"h x 19.69"d
Rectangle 07	VF-R-07 VF-LB-R-07	236.13"	94.38"	ⓐ, 236.5"w x 94.74"h x 19.69"d
Rectangle 08	VF-R-08 VF-LB-R-08	355.19"	94.38"	ⓐ, 355.19"w x 94.74"h x 19.69"d
Square 01	VF-S-01 VF-LB-S-01	35.31"	35.31"	ⓐ, 36.3"w x 35.68"h x 19.69"d
Square 02	VF-S-02 VF-LB-S-02	47.125"	47.125"	ⓐ, 48.11"w x 47.49"h x 19.69"d
Square 03	VF-S-03 VF-LB-S-03	70.75"	70.75"	ⓐ, 71.73"w x 71.12"h x 19.69"d
Square 04	VF-S-04 VF-LB-S-04	94.375"	94.375"	ⓐ, 95.35"w x 94.74"h x 19.69"d



RECTANGLE 03

Light Box Assembly

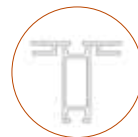
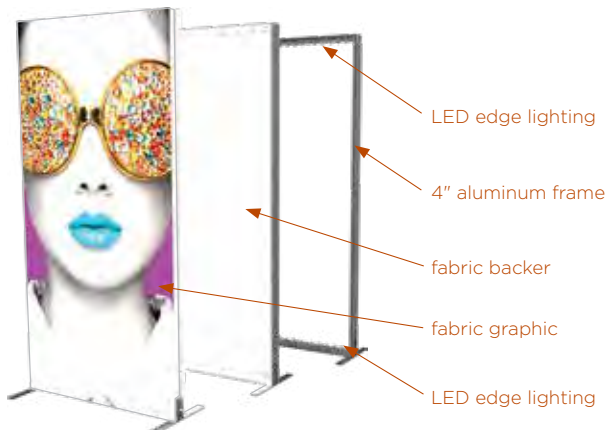

2" banner extrusion profile

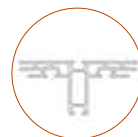

4" light box extrusion profile

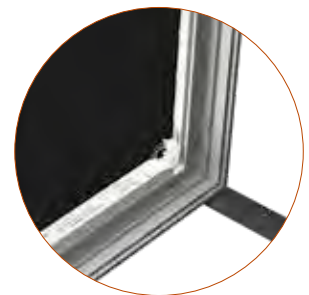

10' Exhibit Kits

Stand apart from the competition with a clean, sophisticated 10' x 10' or 10' x 20' Vector Frame™ Master exhibit kit. These graphic mural kits feature square-corner extrusion frames and push-fit fabric graphics that cover the entire frame. Vector Frame Master kits are easy to assemble and disassemble.



KIT 02



KIT 03*



KIT 04

R



KIT 09



KIT 10



KIT 11

R



10' Exhibit Kits

Vector Frame counter tops are available in your choice of four color options



KIT 13



illuminated wall

KIT 15

R



illuminated wall

KIT 16*

R



slot wall & storage space

KIT 25*



name	code	assembled dimensions
Kit 02	VF-K-02A	Ⓞ 114.65" w x 94.5" h x 16.18" d
Kit 03	VF-K-03	Ⓞ 112.66" w x 94.5" h x 28" d
Kit 04	VF-K-04A	Ⓞ 114.65" w x 94.5" h x 22" d
Kit 09	VF-K-09A	Ⓞ 117" w x 102" h x 23" d
Kit 10	VF-K-10A	Ⓞ 114" w x 98.7" h x 24.13" d
Kit 11	VF-K-11	Ⓞ 119.5" w x 102" h x 22.75" d

name	code	assembled dimensions
Kit 13	VF-K-13	Ⓞ 119.25" w x 102" h x 19.75" d
Kit 15	VF-K-15	Ⓞ 112" w x 95" h x 19.75" d
Kit 16	VF-K-16	Ⓞ 116" w x 95" h x 21.75" d
Kit 25	VF-K-25	Ⓞ 110.25" w x 94.49" h x 39.37" d

*Monitors not included.

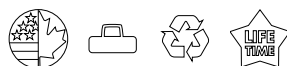

20' Exhibit Kits

The innovative, contemporary and clean appearance of the Vector Frame™ Master line of exhibit kits will captivate your audience. Kits feature push-fit fabric graphics, easy-to-assemble extrusion frames, accent lighting, tables, literature accessories, monitor mounts and interior LED edge lighting where indicated. Customized kits are also available.



name	code	assembled dimensions
Kit 05	VF-K-05A	@ 221.77" w x 94.5" h x 21.66" d
Kit 07	VF-K-07	@ 223.35" w x 94.5" h x 28" d
Kit 08	VF-K-08A	@ 190.24" w x 94.5" h x 54" d
Kit 17	VF-K-17	@ 221.25" w x 102" h x 27.75" d

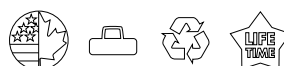

20' Exhibit Kits

illuminated wall ←

KIT 19A
R



KIT 22*



slot wall & storage space

KIT 26*



storage space ←

KIT 27*



name	code	assembled dimensions
Kit 19	VF-K-19A	Ⓞ 221.77" w x 94.5" h x 21.66" d
Kit 22	VF-K-22A	Ⓞ 223.35" w x 94.5" h x 28" d
Kit 26	VF-K-26	Ⓞ 190.24" w x 94.5" h x 54" d
Kit 27	VF-K-27	Ⓞ 221.25" w x 102" h x 27.75" d



OCH2 & OCE-2
wheeled molded cases included
with each kit (p. 153-155)

*Monitors not included.

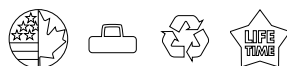

Add a Counter!



COUNTER 01 *R*



COUNTER 02 *R*



COUNTER 03



COUNTER 04 *R*



COUNTER 05

- features locking door and rigid sintra graphics



COUNTER 06

- features locking door and rigid sintra graphics



COUNTER 07

name	code	assembled dimensions
Counter 01	VFC-01	Ⓞ 39.37" w x 36.61" h x 22.44" d
Counter 02	VFC-02	Ⓞ 55.13" w x 40.5" h x 22.5" d
Counter 03	VFC-03	Ⓞ 38.5" w x 40.5" h x 19.88" d
Counter 04	VFC-04	Ⓞ 31" w x 40.5" h x 19" d
Counter 05	VFC-05	Ⓞ 39.76" w x 40.5" h x 22.75" d
Counter 06	VFC-06	Ⓞ 41.7" w x 40.5" h x 20.75" d
Counter 07	VFC-07	Ⓞ 46" w x 40.5" h x 22.64" d

Vector Frame counter tops are available in your choice of four color options



silver black mahogany natural



counters come in OCH2 case

Suspend & Captivate



Vector Frame™ push-fit fabric hanging light boxes are a premium range of illuminated, extrusion-based rectangular shapes. Dominate any interior and trade show hall with a captivating hanging light box!

3'H



4'H *R*



5'H



6'H



size	code	assembled dimensions
10'w x 3'h	VF-LB-H-10-03	Ⓞ 118.11" w x 35.43" h x 3.94" d
15'w x 3'h	VF-LB-H-15-03	Ⓞ 177.17" w x 35.43" h x 3.94" d
20'w x 3'h	VF-LB-H-20-03	Ⓞ 236.22" w x 35.43" h x 3.94" d
30'w x 3'h	VF-LB-H-30-03	Ⓞ 354.33" w x 35.43" h x 3.94" d
40'w x 3'h	VF-LB-H-40-03	Ⓞ 472.44" w x 35.43" h x 3.94" d
10'w x 4'h	VF-LB-H-10-04	Ⓞ 118.11" w x 47.24" h x 3.94" d
15'w x 4'h	VF-LB-H-15-04	Ⓞ 177.17" w x 47.24" h x 3.94" d
20'w x 4'h	VF-LB-H-20-04	Ⓞ 236.22" w x 47.24" h x 3.94" d
30'w x 4'h	VF-LB-H-30-04	Ⓞ 354.33" w x 47.24" h x 3.94" d
40'w x 4'h	VF-LB-H-40-04	Ⓞ 472.44" w x 47.24" h x 3.94" d

size	code	assembled dimensions
10'w x 5'h	VF-LB-H-10-05	Ⓞ 118.11" w x 59.06" h x 3.94" d
15'w x 5'h	VF-LB-H-15-05	Ⓞ 177.17" w x 59.06" h x 3.94" d
20'w x 5'h	VF-LB-H-20-05	Ⓞ 236.22" w x 59.06" h x 3.94" d
30'w x 5'h	VF-LB-H-30-05	Ⓞ 354.33" w x 59.06" h x 3.94" d
40'w x 5'h	VF-LB-H-40-05	Ⓞ 472.44" w x 59.06" h x 3.94" d
10'w x 6'h	VF-LB-H-10-06	Ⓞ 118.11" w x 70.87" h x 3.94" d
15'w x 6'h	VF-LB-H-15-06	Ⓞ 177.17" w x 70.87" h x 3.94" d
20'w x 6'h	VF-LB-H-20-06	Ⓞ 236.22" w x 70.87" h x 3.94" d
30'w x 6'h	VF-LB-H-30-06	Ⓞ 354.33" w x 70.87" h x 3.94" d
40'w x 6'h	VF-LB-H-40-06	Ⓞ 472.44" w x 70.87" h x 3.94" d



Sharp & Sophisticated

Vector Frame™ Towers are superior interior displays that couple aluminum extrusion frames with push-fit SEG graphics. Illuminated and non-illuminated options available. Perfect for corporate events, concerts, stage sets, retail environments, tradeshows and more!

comes in three different heights!



STANDARD TOWER



BACKLIT TOWER



STANDARD TOWER WITH MONITOR



BACKLIT TOWER WITH MONITOR

size	name	code	assembled dimensions
3' x 8'	Tower 01	VF-TWR-01	Ⓞ 35.97" w x 96.02" h x 35.97" d
4' x 8'	Tower 02	VF-TWR-02	Ⓞ 47.97" w x 96.02" h x 47.97" d
3' x 10'	Tower 03	VF-TWR-03	Ⓞ 35.97" w x 120.02" h x 35.97" d
4' x 10'	Tower 04	VF-TWR-04	Ⓞ 47.97" w x 120.02" h x 47.97" d
3' x 12'	Tower 05	VF-TWR-05	Ⓞ 35.97" w x 144.02" h x 35.97" d
4' x 12'	Tower 06	VF-TWR-06	Ⓞ 47.97" w x 140.02" h x 47.97" d
3' x 8'	Backlit Tower 01	VF-BL-TWR-01	Ⓞ 35.97" w x 96.02" h x 35.97" d
4' x 8'	Backlit Tower 02	VF-BL-TWR-02	Ⓞ 47.97" w x 96.02" h x 47.97" d
3' x 10'	Backlit Tower 03	VF-BL-TWR-03	Ⓞ 35.97" w x 120.02" h x 35.97" d
4' x 10'	Backlit Tower 04	VF-BL-TWR-04	Ⓞ 47.97" w x 120.02" h x 47.97" d
3' x 12'	Backlit Tower 05	VF-BL-TWR-05	Ⓞ 35.97" w x 144.02" h x 35.97" d
4' x 12'	Backlit Tower 06	VF-BL-TWR-06	Ⓞ 47.97" w X 140.02" h X 47.97" d

size	name	code	assembled dimensions
3' x 8'	Monitor Tower 01	VF-TWR-01-MM	Ⓞ 35.97" w x 96.02" h x 35.97" d
4' x 8'	Monitor Tower 02	VF-TWR-02-MM	Ⓞ 47.97" w x 96.02" h x 47.97" d
3' x 10'	Monitor Tower 03	VF-TWR-03-MM	Ⓞ 35.97" w x 120.02" h x 35.97" d
4' x 10'	Monitor Tower 04	VF-TWR-04-MM	Ⓞ 47.97" w x 120.02" h x 47.97" d
3' x 12'	Monitor Tower 05	VF-TWR-05-MM	Ⓞ 35.97" w x 144.02" h x 35.97" d
4' x 12'	Monitor Tower 06	VF-TWR-06-MM	Ⓞ 47.97" w x 140.02" h x 47.97" d
3' x 8'	Backlit Monitor Tower 01	VF-BL-TWR-01-MM	Ⓞ 35.97" w x 96.02" h x 35.97" d
4' x 8'	Backlit Monitor Tower 02	VF-BL-TWR-02-MM	Ⓞ 47.97" w x 96.02" h x 47.97" d
3' x 10'	Backlit Monitor Tower 03	VF-BL-TWR-03-MM	Ⓞ 35.97" w x 120.02" h x 35.97" d
4' x 10'	Backlit Monitor Tower 04	VF-BL-TWR-04-MM	Ⓞ 47.97" w x 120.02" h x 47.97" d
3' x 12'	Backlit Monitor Tower 05	VF-BL-TWR-05-MM	Ⓞ 35.97" w x 144.02" h x 35.97" d
4' x 12'	Backlit Monitor Tower 06	VF-BL-TWR-06-MM	Ⓞ 47.97" w X 140.02" h X 47.97" d

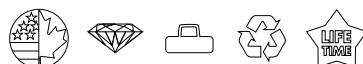

custom exhibits that create
CAPTIVATING ENVIRONMENTS



UNIQUELY DESIGNED | CUSTOM BUILT



ORBITAL EXPRESS™

Truss

Bold & Versatile



Details

- bold, contemporary and industrial, Orbital Express™ Truss exhibits dominate the show floor
- reconfigurable exhibit backwalls, islands and counters feature a fixed number of parts and connectors
- NO TOOLS required for assembly! Simply twist & lock is all you have to do
- all Orbital Express Truss display pieces, fabric and UV graphics are made in North America
- custom solutions available

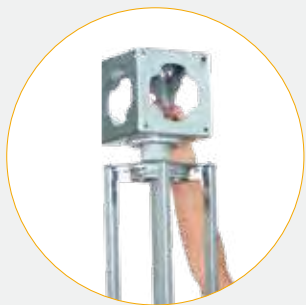

toolless assembly - twist & lock



add a counter

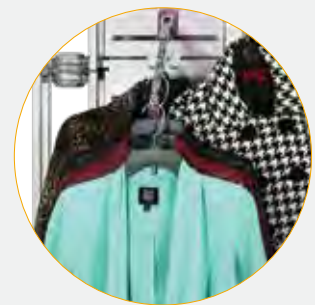

add a wire or hanging rack to your kit



10' x 10' Exhibit Kits

Orbital Express™ Truss features dozens of professionally designed "off the shelf" kits for a variety of booth sizes and configurations. Each kit comes complete with all the parts, fixtures and fittings you need to create a successful exhibit, including (depending on the kit) low voltage spotlights and adjustable tabletops. A benefit to this versatile system is that it enables you to reconfigure kits in multiple ways and combinations using the same parts. Orbital Express Truss can also be easily configured to fit your custom needs!

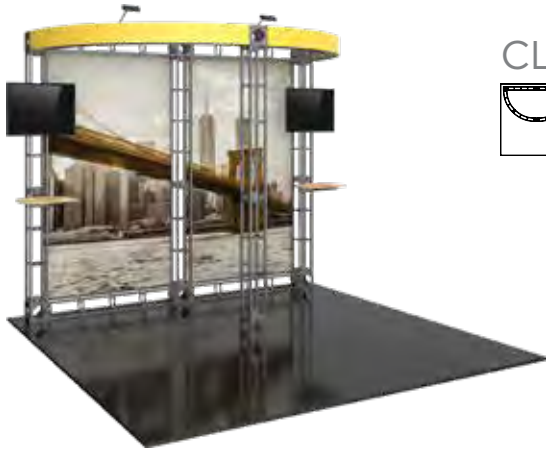

CLIO*



LUNA 10



HELIOS



SIRIUS

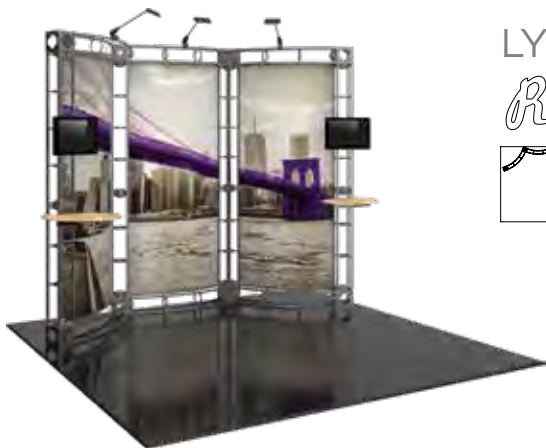

LYNX*



name	code	assembled dimensions
Clio	OR-K-CO1	Ⓞ 120" w x 96" h x 120" d
Luna	OR-K-LU1	Ⓞ 120" w x 96" h x 120" d
Helios	OR-K-HE1	Ⓞ 120" w x 96" h x 120" d
Sirius	OR-K-SR1	Ⓞ 120" w x 96" h x 120" d
Lynx	OR-K-LX1	Ⓞ 120" w x 96" h x 120" d

10' x 20' Exhibit Kits

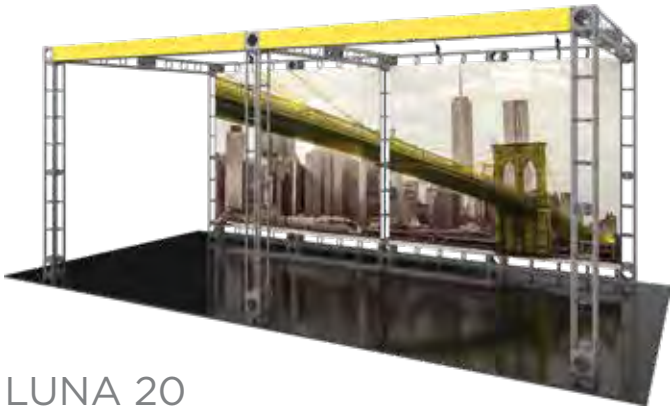

LUNA 20

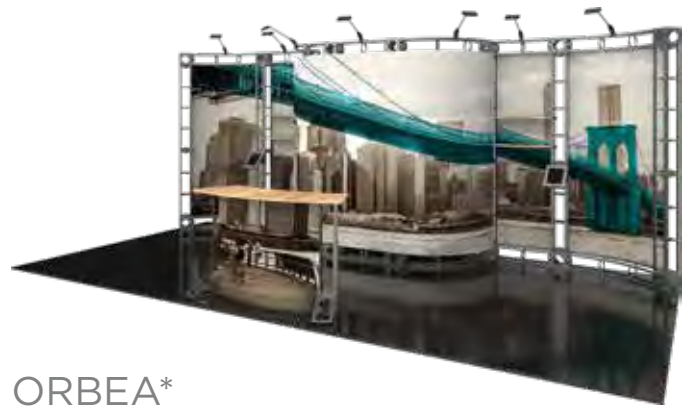
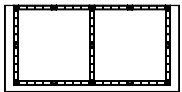

ORBEA*

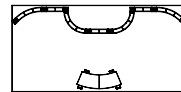

*includes counter

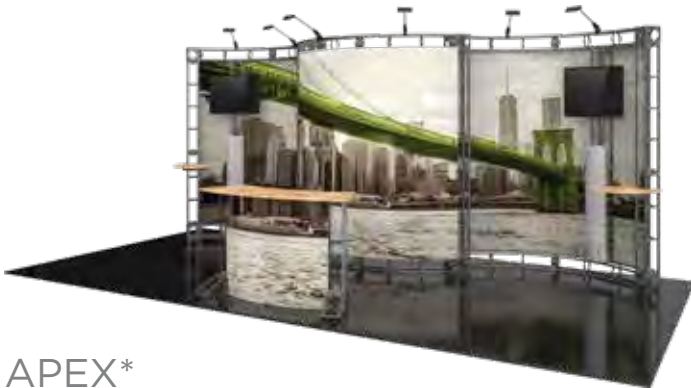

APEX*

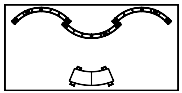

*includes counter and literature racks



CALLISTO

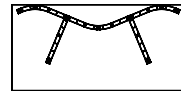

name	code	assembled dimensions
Luna	OR-K-LU2	Ⓞ 240" w x 96" h x 120" d
Orbea	OR-K-OB1	Ⓞ 240" w x 96" h x 120" d
Apex	OR-K-AX1	Ⓞ 240" w x 96" h x 120" d
Callisto	OR-K-CI1	Ⓞ 240" w x 96" h x 120" d

*Monitors and monitor mounts not included.



10' x 20' Exhibit Kits

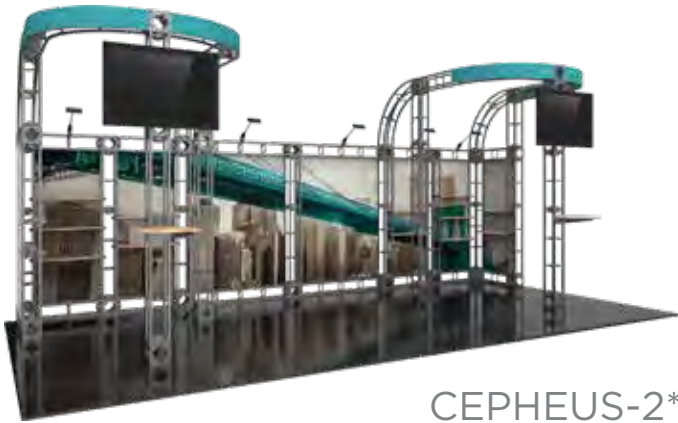

CEPHEUS-2*

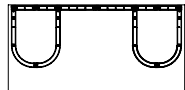

backwall height = 72.5"



ANTARES

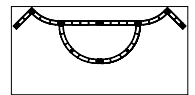

PHOENIX

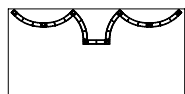

POLARIS

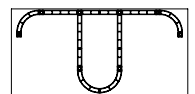

name	code	assembled dimensions
Cepheus 2	OR-K-CE1-2	@ 240"w x 96"h x 120"d
Antares	OR-K-AT1	@ 240"w x 96"h x 120"d
Phoenix	OR-K-PX1	@ 240"w x 96"h x 120"d
Polaris	OR-K-PR1	@ 240"w x 96"h x 120"d



20' x 20' Island Kits

Orbital Express™ Truss features dozens of professionally designed "off the shelf" kits for a variety of booth sizes and configurations. Each kit comes complete with all the parts, fixtures and fittings you need to create a successful exhibit, including (depending on the kit) low voltage spotlights and adjustable tabletops. A benefit to this versatile system is that it enables you to reconfigure kits in multiple ways and combinations using the same parts. Orbital Express Truss can also be easily configured to fit your custom needs!

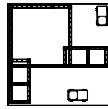

*includes counters

ONYX

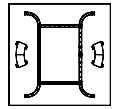

*includes counters

AARHUS

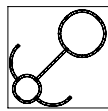

CORVUS *R*

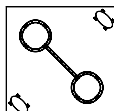

*includes counters

GEMINI

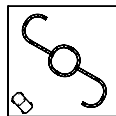

*includes counter

ZENIT

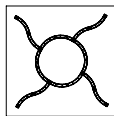
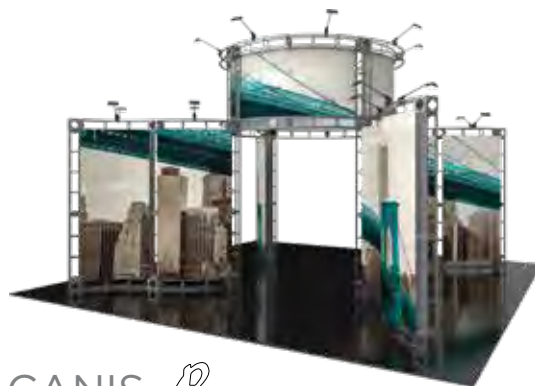

CANIS *R*

name	code	assembled dimensions
Onyx	OR-K-ONI	Ⓞ, 240" w x 240" d
Corvus	OR-K-CV1	Ⓞ, 240" w x 240" d
Zenit	OR-K-ZE1	Ⓞ, 240" w x 240" d

name	code	assembled dimensions
Aarhus	OR-K-AH1	Ⓞ, 240" w x 240" d
Gemini	OR-K-GE1	Ⓞ, 240" w x 240" d
Canis	OR-K-CA1	Ⓞ, 240" w x 240" d



10' x 10' Hercules Kits

The Hercules line of Orbital Express™ Truss features basic backwalls and kits in a variety of sizes to suit a range of space needs. A benefit to this versatile system is that it enables you to reconfigure kits in multiple ways and combinations using the same parts. Simply add or subtract from any Hercules kit to create a new appearance for every event or tradeshow!

Truss counter tops are available in your choice of four color options



HERCULES 08

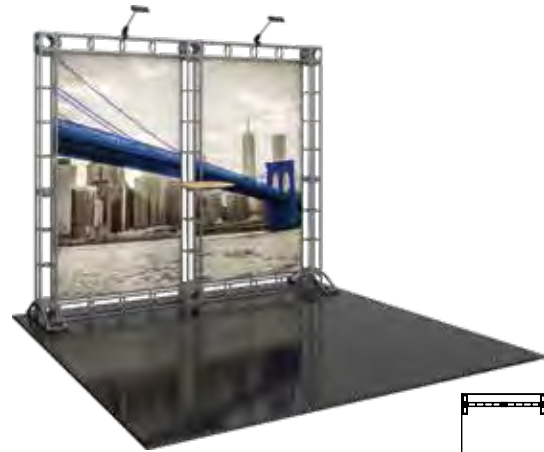

HERCULES 09



HERCULES 10

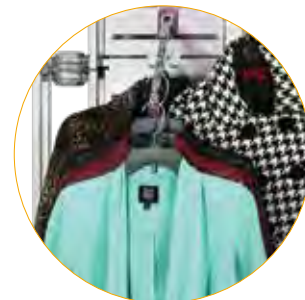

name	code	assembled dimensions
Hercules 08	OR-K-HC08	Ⓜ 120" w x 96" h x 120" d
Hercules 09	OR-K-HC09	Ⓜ 120" w x 96" h x 120" d
Hercules 10	OR-K-HC10	Ⓜ 120" w x 96" h x 120" d

Easily add an accessory wire or hanging rack to your kit!



10' x 20' Hercules Kits



HERCULES 12

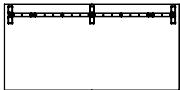

HERCULES 13

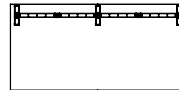

HERCULES 15

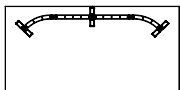

Add a counter!

Truss counter tops are available in your choice of four color options



silver black mahogany natural

name	code	assembled dimensions
Hercules 12	OR-K-HC15	Ⓞ 240" w x 96" h x 120" d
Hercules 13	OR-K-HC13	Ⓞ 240" w x 96" h x 120" d
Hercules 15	OR-K-HC15	Ⓞ 240" w x 96" h x 120" d



Accessorize

Accessories such as tabletops, shelves, literature holders and monitor mounts add functionality and options to your display. Truss tabletops and shelves come in four tabletop colors. No tools needed for assembly.

LAMINATE TABLETOPS



Laminate tabletops & shelving are available in your choice of four color options



silver black mahogany natural

Placement of tables is your choice!

TRUSS MONITOR MOUNTS *R*



OPTI-MOUNT 1

23"-42" LCD
max weight = 50 lbs

code	assembled dimensions
OR-SM-MB	Ⓞ 10" w x 8.86" h x 2" d



OPTI-MOUNT 2

32"-55" LCD
max weight = 80 lbs

code	assembled dimensions
OR-M-MB	Ⓞ 17.6" w x 16.7" h x 1.6" d



OPTI-MOUNT 3

37"-70" LCD
max weight = 150 lbs

code	assembled dimensions
OR-LG-MB	Ⓞ 25.9" w x 16.7" h x 1.6" d

INTERNAL SHELVING

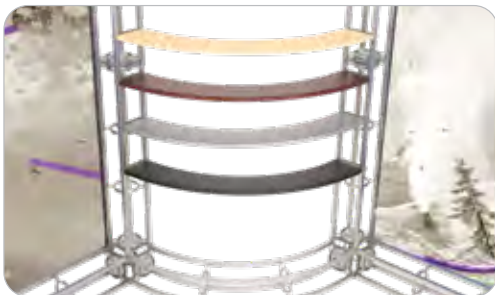

- available in choice of four finishes
- 24" straight span, 36" straight span, and 46" straight span shelves available
- 45° curved and 90° curved shelves

LIT RACK *R*

- 10 pocket clamp on literature rack
- note: rack may not fit into the standard kit packaging solution/molded case
- toolless attachment

code	assembled dimensions
OR-STG	Ⓞ 10" w x 8.86" h x 2" d



Add a Counter!

Truss Counters and Podiums have several attractive designs to choose from with a sleek plex top as an available option. Choose from four tabletop colors. Graphic options are also available for Truss Counters. No tools needed for assembly.



RECTANGLE *R*



OVAL *R*



RACETRACK



CURVE *R*

name	code	assembled dimensions
Rectangle	OR-TC01	Ⓞ 46" w x 37" h x 28" d
Oval	OR-TC02	Ⓞ 46" w x 37" h x 28" d

name	code	assembled dimensions
Racetrack	OR-TC03	Ⓞ 46" w x 37" h x 28" d
Curve	OR-TC04	Ⓞ 61" w x 37" h x 28" d

Truss counter tops are available in your choice of four color options



Add Functionality with a Rack

Orbital Express™ Truss Merchandising Racks add functionality and options to any Orbital Truss kit. Accessory options offer multiple configurations and no tools are needed for assembly. Accessory panels are an a la carte add on option for 10ft, 20ft and island Orbital kits. Horizontal support bar needed for proper connection.



WIRE RACK

- grid wall with hook brackets
- hook brackets sold separately
- supports approx. 8 lbs. per panel
- OR-24-MP-M mounts to verticals
- horizontal connector required to hang properly (sold separately)

code	assembled dimensions
OR-24/36/46-MP	Ⓞ 6.19" w x 22.92" h x 1.37" d



HANGING RACK

- slot wall with hook brackets
- hook brackets sold separately
- supports approx. 8 lbs. per panel
- horizontal connector required to hang properly (sold separately)

code	assembled dimensions
OR-36/46-SP	Ⓞ 11.12" w x 37.26" h x 92" d



WIRE/HANGING RACK CONNECTOR

- required to mount wire and hanging rack
- includes quick lock truss connectors

code	assembled dimensions
OR-24/36/46-SST	Ⓞ 6.19" w x 22.92" h x 1.37" d



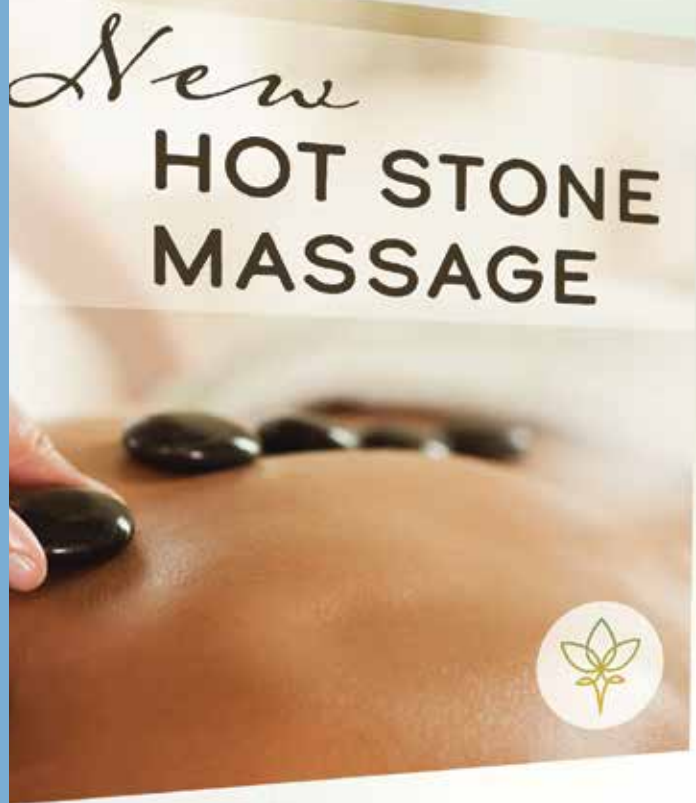

ACCENTS & *accessories*

Impressive & Portable

Counter tops are available in your choice of four color options



Counters and kiosks can be used to accessorize any trade show, event or permanent space. With a variety of different counters and kiosks to choose from, mix and match to create the best-suited display.



clear shelf

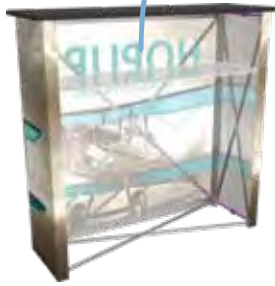

HOPUP™ COUNTER



- collapsible display counter
- hook & loop applied fabric graphics
- includes clear internal shelf

code	assembled dimensions
HOP-CT-2	41.75" w x 39.69" h x 14.25" d



white shelf



EMBRACE™ COUNTER



- collapsible display counter
- includes white internal shelf
- push-fit fabric graphics

code	assembled dimensions
EMB-CT EMB-CT-BL	41" w x 40.5" h x 15.75" d



MODULATE™ COUNTER



- magnetic, tubular frame with snap buttons
- fabric graphic attaches via hook & loop around the frame & zips in the back
- internal shelf provides area to store materials

code	assembled dimensions
MOD-CNTR-M	31.5" w x 40" h x 23.5" d



Counters & Charging Stations

CAMPAIGN



- hook & loop PVC graphic
- quick assembly
- strong & easy-to-clean plastic parts

code	assembled dimensions
CP-B3	32" w x 34.5" h x 18.5" d (counter, not including canopy)

PERCH



Short Perch shown



- pole banner attachment for standard 6' or 8' wide tables
- hardware kit is universal for all height options
- table throw sold separately

code	width	heights	assembled dimensions
PERCH-6	74.75"	18.75" (small), 44" (med), 68.5" (large)	75.48" w x 70.6" h x 1.18" d
PERCH-8	99"	18.75" (small), 44" (med), 68.5" (large)	99.61" w x 70.6" h x 1.18" d

CHARGING TOWER



Charging stations are available in four color options



- features 16 high-speed charging tips: (8) Micro USB for Android devices and (8) Apple 8-pin for Apple iPhone/iPad/Lightning devices
- features a circular fabric header for branding and an illuminated fabric center structure

code	assembled dimensions
FMLT-CHRG-01	33.56" w x 86.81" h x 33.46" d

CHARGING COUNTER



top view

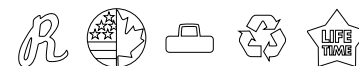

- 23.72" w x 41.54" h x 23.62" d
- features 8 high-speed charging tips: (4) Micro USB for Android devices and (4) Apple 8-pin for Apple iPhone/iPad/Lightning devices
- features stretch fabric graphic

code	assembled dimensions
FMLT-CHRG-CNTR-01-G	23.72" w x 41.54" h x 23.62" d

Freestanding Tablet Stands

UNIVERSAL TABLET STAND

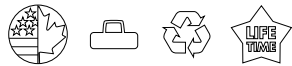

- security screws, allen key and bolts make the unit both durable and theft resistant
- base can be bolted to the floor for extra security
- features a telescopic, adjustable-height pole

code	assembled dimensions
PAD21-04	Ⓞ 17.38" w x 28.06" h x 13.75" d

TABLET STAND



- security screws and allen key make the unit both durable & theft resistant
- features a telescopic, adjustable-height pole
- small stand holds 7"-10.5" tablets
- large stand holds 10.5"-13" tablets

code	assembled dimensions
TABLET-STD-ESS-SH-S	Ⓞ 14.5" w x 30" h x 14.5" d
TABLET-STD-ESS-SH-L	Ⓞ 14.5" w x 30.75" h x 14.5" d



STAND 02

STAND 03

STAND 04

STAND 05

TENSION FABRIC IPAD STANDS



- iPad holders (2nd, 3rd, 4th gen and Air models)*
- pillowcase fabric graphic
- iPad stand 02 and 03 available for rent
- iPad stand 05 features a small monitor mount*, holds 32" TV/32 lbs max

name	code	assembled dimensions
ipad stand 02	TABLET-STD-02	Ⓞ 20.2" w x 85.11" h x 23.7" d
ipad stand 03	TABLET-STD-03	Ⓞ 19.98" w x 64.34" h x 15.2" d
ipad stand 04	TABLET-STD-04	Ⓞ 26.26" w x 46.26" h x 22.64" d
ipad stand 05	TABLET-STD-05	Ⓞ 30" w x 84" h x 23" d

*Monitor and tablets not included.

Kiosks



FORMULATE® KIOSKS



- lightweight aluminum tube frames with stretch zipper pillowcase fabric graphic
- supports medium monitor*

name	code	assembled dimensions
kiosk 01	FMLT-KIOSK-01	Ⓞ 31.17" w x 94.84" h x 41.68" d
kiosk 02	FMLT-KIOSK-02	Ⓞ 64.5" w x 96" h x 37.71" d
kiosk 03	FMLT-KIOSK-03	Ⓞ 55.12" w x 95.93" h x 38.48" d
kiosk 04	FMLT-KIOSK-04	Ⓞ 42.13" w x 96" h x 25.59" d

*Monitors not included.



FREESTANDING PORTABLE MONITOR KIOSK

- supports large 32-70" monitor*
- max weight = 40 lbs



FREESTANDING MONITOR KIOSK

- large or medium monitor* bracket
- max weight = 40 lbs
- medium holds 32-55" monitor
- large holds 37-70" monitor
- comes with 1 OCE case
- available to rent



FREESTANDING MONITOR KIOSK W/ SHELF

- medium holds 32-55" monitor*
- large holds 32-70" monitor
- shelf weight supports 15 lbs.



FREESTANDING SHELF

- three shelves support approx. 15 lbs each



VIBE MONITOR KIOSK

- medium monitor* bracket
- max weight = 50 lbs
- comes with 1 OCH2 case
- available to rent

add to your custom exhibit!

FREESTANDING MONITOR KIOSKS

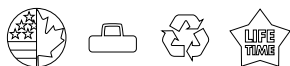

Freestanding monitor kiosks are perfect for conference rooms, court rooms, corporate office spaces, lobby areas and more. Kiosk bases are made with aluminum extrusion and come with a lifetime warranty.

name	code	assembled dimensions
freestanding portable monitor kiosk	FREESTANDING-SPLIT-MM	Ⓞ 26.25" w x 75.25" h x 23.56" d
freestanding monitor kiosk	PM4S3-MK-M/L	Ⓞ 25.59" w x 70.98" h x 25.59" d
freestanding monitor kiosk w/ shelf	PM4S3-MK-M-MSHELF PM4S3-MK-L-MSHELF	Ⓞ 25.59" w x 75.25" h x 25.59" d
freestanding shelf	PM4S3-MK-SHELF-UNIT	Ⓞ 25.53" w x 70.98" h x 25.59" d
vibe monitor kiosk	VB-MK-01	Ⓞ 30" w x 78.38" h x 23.6" d

*Monitors not included.



KIOSK 01

KIOSK 02



top view
one monitor mount



top view
two monitor mounts

VECTOR FRAME MONITOR KIOSKS

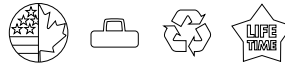

- single or double-sided graphics available
- can hold your choice of one or two monitors*
- comes in 1 OCH case
- supports 32.55" monitor; max weight = 30 lbs. each

name	code	assembled dimensions
monitor kiosk 01	VF-MK-01-SS VF-MK-01-DS	35.68" w x 94.49" h x 25.59" d
monitor kiosk 02	VF-MK-02-SS VF-MK-02-DS	47.49" w x 94.49" h x 25.59" d

*Monitors not included.



TWIST 3 DISPLAY CABINET



- portable, collapsible, illuminated display cabinet
- heavy-duty plastic and 12 plexiglass window panels
- includes three integrated 14" w x 14" d shelves with three overhead lights
- shelves hold max 15 lbs
- optional branded graphic panels (14.56" w x 19.88" h) are offered a la carte
- easily collapses and packs into portable carry bag

name	code	assembled dimensions
twist 3	TWIST-3	16.25" w x 61.38" h x 16.25" d



TWIST 4 DISPLAY CABINET



- portable, collapsible, illuminated display cabinet
- heavy-duty plastic and 16 plexiglass window panels
- includes four integrated 14" w x 14" d shelves with four overhead lights
- shelves hold max 15 lbs
- optional branded graphic panels (14.56" w x 19.88" h) are offered a la carte
- easily collapses and packs into portable carry bag

name	code	assembled dimensions
twist 4	TWIST-4	16.25" w x 81.25" h x 16.25" d

Sign Stands

Easily display a graphic or message with a versatile and easy-to-assemble sign stand. We offer stands that feature adjustable posts, portrait and landscape sign configurations and more.

ADVOCATE



- telescopic post offers variable height from 30.5"-48"
- aluminum sign holder holds 8.5" w x 11" h paper
- frame can be rotated 360 degrees or any desired angle
- chrome finish

name	code	assembled dimensions
advocate sign stand	ADVOCATE	@_ 9.75" w x 30.5" - 48" h

SNAPPER STAND



- stylish, easy snap-open 11" w x 17" h frame
- frame can be used in portrait and landscape configurations
- silver aluminum sign holder, post and base

name	code	assembled dimensions
snapper sign stand	SNP-STAND	@_ 18.25" w x 40" h



Sign Stands

OBSERVE PRO



- lightweight, snap-together info center with 12" dia. base
- stylish curved header & adjustable brochure holder
- accepts 8.5" w x 11" h literature & graphic

name	code	assembled dimensions
observe pro	OBS-LP-SYS	Ⓞ 12" w x 48" h

OBSERVE DELUXE



- stylish double-sided curved design
- holds two 24" w x 36" h bubble graphics
- recommended printing material: .040"-.125"
- elegant brushed silver
- sturdy steel base with removable and adjustable brochure pockets

name	code	assembled dimensions
observe deluxe	OBS-DLX	Ⓞ 17.17" w x 74.5" h x 23.5" d

WEDGE



- combine multiple units for longer and taller displays
- graphic size is variable
- black only
- graphics not included

name	code	assembled dimensions
wedge	WED-1-B	Ⓞ 11.88" w x 3.25" h x 15.25" d

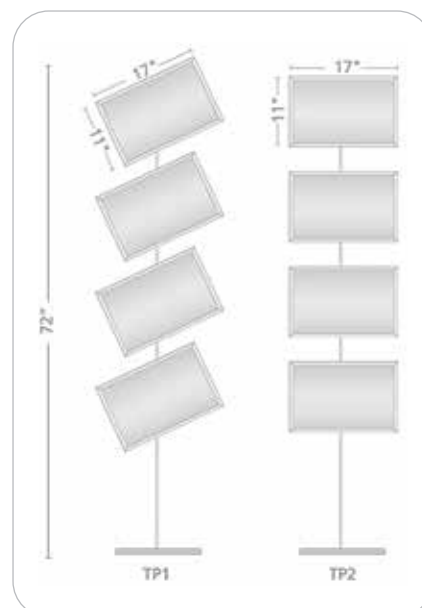

TRAPPA POST



- choice of silver or black snap frames, large or small, landscape, portrait or diagonal
- front loading graphic mechanism makes graphic changes easy
- includes clear protective lenses
- sturdy aluminum posts and heavy domed steel plate ensure stability

Literature Racks



ZEDUP 1

- 6 pocket rack
- can be stored or shipped loaded with literature
- comes in black or silver

name	code	assembled dimensions
zedup 1	ZD-1-B ZD-1-S	📏 10.88" w x 60.5" h x 14.38" d



QUANTUM SINGLE-SIDED

- 4 pocket rack
- collapsible
- constructed from plastic for light weight

name	code	assembled dimensions
quantum single-sided	QNTM-SS	📏 11.25" w x 54.5" h x 15" d



ZEDUP LITE

- 6 pocket rack
- collapsible
- lightweight version of the ZedUp
- constructed from aluminum & plastic for reduced weight

name	code	assembled dimensions
zedup lite	ZD-LITE	📏 14.63" w x 59" h x 11.13" d



OASIS

- highly portable
- three arm collapsible bag dispenser
- shiny silver finish

name	code
oasis	OASIS



STEP STOOL

- sturdy EZ FOLDZ step stool
- 300 lb capacity
- folds flat for storage & transport
- blue only

name	code
step stool	STEP-STOOL-BLUE

Slimline LED Lighting



LED FLOOD

- low voltage 12 watt spotlight
- 17.16" long from end to end
- mounts to dovetails and extrusion channel
- comes in set of 2
- available in black only



name	code
LED flood	LUM-LED4-ORL-B



LED SPOT

- low voltage 5 watt slender spotlight
- 17.18" long from end to end
- mounts to banner stands
- available in black only

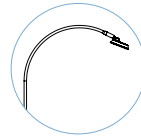

name	code
LED spot	LUM-LED3-ORL-B



LED STRIP

- low voltage 12 watt
- 16.1" long from end to end
- mounts to dovetails and extrusion channel
- comes in set of 2
- available in black only

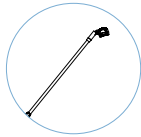

name	code
LED strip	LUM-LED5-ORL-B



LED EXHIBITION

- low voltage 12 watt spotlight
- 17.13" long from end to end
- mounts to extrusion channels
- comes in set of 2
- available in black only

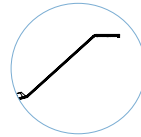

name	code
LED exhibition	LUM-LED6-ORL-B



LUMINA 200 LED

- LED Lumina 200 floodlight
- uses multi cups chip on board (MCOB) light technology and features a slim profile
- LED rated for 20,000 continuous hours
- 19" long from end to end
- available in black or silver

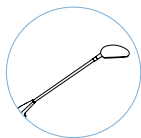

name	code
lumina 200 LED	LUM-LED2-ORL-B/S



LED ECO

- economy LED floodlight
- uses multi cups chip on board (MCOB) light technology and features a slim profile
- LED rated for 20,000 hours
- 12 watt
- 2.5 meter from transformer to light; 1.3 meter from outlet to transformer
- UL approved

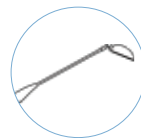

name	code
LED eco	LUM-LED7-ORL-B (set of 2) LUM-LED7-ORL-B-EXT (single)



LED LIGHT BATTERY PACK

- 8.5" h x 3" h x 2.5" d
- rechargeable battery pack provides electricity for hours
- compatible with quick charge 3.0 USB port, two 2.4 USB ports and U.S. & European AC
- comes in sturdy carry box



name	code
LED light battery pack	BATTERY-PACK-1



Lighting



ZOOM TENT LIGHT KIT



- compatible with Zoom Economy and Standard 10' & 20' Tents
- lights attach to Economy frames using magnets and Standard frames using hook & loop
- connect all lights together and plug into a single portable battery pack

name	code
zoom tent light kit	ZM-TNT-LED-01



UNIVERSAL LIGHT CLAMP KIT

- comes standard with the Lumina 1, 3, 4, 5, 6, 8 and allows our lights to fit a majority of banners, truss & panel kits
- UNI-LT-CLP50 comes only with bracket

name	code
universal light clamp kit	UNI-LT-CLP30 UNI-LT-CLP50



SPT CASE

- EVA semi-rigid lighting case
- foam-lined padded compartments
- holds two Lumina 200 lights & power supply

name	code
spt case	SPT-CASE



LED FLOOD LIGHT

- 85-265 voltage, 42 watt LED Flood light (equivalent to 400 watt halogen)
- projects cool WHITE light
- angles to 120°
- UL approved

name	code	assembled dimensions
LED flood light	LED-FLOOD	Ⓜ, 7.4" w x 9.44" h x 5.11" d



MINI LED FLOOD LIGHT

- 10 watt LED Flood light
- projects cool WHITE or RGB spectrum light
- remote control provided with RGB version
- angles to 120°
- UL approved

name	code	assembled dimensions
mini LED flood light	LED-10W-FLOOD-RGB LED-10W-FLOOD-W	Ⓜ, 4.49" w x 3.39" h x 3.98" d

use to illuminate fabric counters, funnels and columns



WARM WHITE

Features a warm white LED light output; good for light-colored and neutral graphic prints. 3,000K



COOL WHITE

Features a cool LED light output; good for darker graphic prints. 6,000K



RGB

Features multi-pattern flashing RGB LED light output; RGB spectrum cannot be controlled.

COLOR BLAST ACCENT LIGHTS

- 85-265 voltage, 13 watt LED blast light
- projects your choice of warm or cool WHITE, and a RGB spectrum flashing pattern
- 7" round x 7" h (when faceplate is flush with base and not angled)
- angles to 60°
- UL approved

name	code
color blast accent lights	LED-WRM-WHT-BLAST LED-COOL-WHT-BLAST LED-RGB-BLAST



It's critical to protect your tradeshow exhibit investment with a quality constructed transit and shipping case. An extensive selection of exhibit and display cases and crates to choose from that are all made in North America and are designed to house specific lines of exhibits and displays for maximum portability and protection during shipping.

LIGHTING & ACCESSORY CASE



- ideal for lights and accessories
- secure straps help to ensure case will remain closed during transport

name	code	weight	assembled dimensions
lighting & accessory case	OCA-2	8 lbs.	ⓐ interior: 32.81" w x 4.13" h x 13.75" d ⓑ exterior: 34" w x 7" h x 15" d

BANNER STAND CASE



- this expandable shipping case fits up to three swivel-foot banner stands with bags or one premium stand with bag
- also used for Formulate® Lite displays
- case fits all banners less than 47.5" wide

name	code	weight	assembled dimensions
banner stand case	OCB-2	9 lbs.	ⓐ interior: 13.5" w x 30.29" - 45.14" h x 5" d ⓑ exterior: 18.12" w x 34.49" - 54.24" h x 7.4" d

SMALL & LARGE GRAPHIC CASES



- premium latches for maximum strength
- built in wheels and easy-to-grip molded handle

name	code	weight	assembled dimensions
small graphic case	OCS	18 lbs.	ⓐ interior: 14" w x 39.81" h x 13.25" d ⓑ exterior: 18" w x 42.25" h x 16.5" d
large graphic case	OCL	20 lbs.	ⓐ interior: 14" w x 51.5" h x 13.25" d ⓑ exterior: 18" w x 55.13" h x 16.5" d

EXPANDABLE CASE



- the perfect expandable protective case for all Formulate® exhibit kits, hanging structures and more
- convenient lock guides for easier closure
- to use as a counter, simply separate the top and bottom and add the optional wood counter top, available in your choice of silver, black, mahogany or natural

name	code	weight	assembled dimensions
expandable case	OCE-2	36 lbs.	ⓐ interior: 14" w x 40.75" - 65" h x 13.375" d ⓑ exterior: 16.75" w x 41.25" - 65.5" h x 16.75" d



Cases

STANDARD WHEELED DISPLAY CASE



left view



top view

Optional counter top for OCE-2 & OCX are available in four color options



- premium latches for maximum strength
- optional wood counter top can be added in your choice of silver, black, mahogany or natural

name	code	weight	assembled dimensions
standard wheeled display case	OCX	32 lbs.	interior: 23.5" w x 35.75" h x 13.07" d exterior: 26.73" w x 39.49" h x 17.05" d

HOPUP-MEDIUM WHEELED CASE



- ideal for Hopup backwall displays (fits up to 4x3 hopup)
- built-in handle and wheels for easy transport

name	code	weight	assembled dimensions
hopup/medium wheeled case	OC-HOP	17 lbs.	interior: 13.5" w x 35.5" h x 13.5" d exterior: 15.5" w x 35.69" h x 17" d

TROLLEY ROLLER



- lightweight trolley for Hopup™ and Embrace™ displays
- collapsible, plastic and easy to transport

name	code	weight	assembled dimensions
trolley roller	TROLLEY	holds 55 lbs. max	9.25" w x 20" - 46.63" h x 12.75" d



LARGE DISPLAY CASES



OCH



OCH2

OCH

- roto-molded case for exhibits, graphics & accessories
- secure reinforced straps help to ensure case will remain closed during transport
- strong yet lightweight

OCH2

- heavy-duty shipping and storage case
- ideal for Linear hybrid displays
- secure reinforced straps help to ensure case will remain closed during transport
- wheels and handles recessed

name	code	weight	assembled dimensions
large display case	OCH	22 lbs.	☺ interior: 23.25" w x 7.63" h x 46.5" d exterior: 26" w x 12" h x 50" d
large display case 2	OCH2	30 lbs.	☺ interior: 24.13" w x 12.25" h x 47.25" d exterior: 29" w x 15" h x 52" d

FREIGHT CASES



OCFM



OCF

OCFM

- interlocking surface to enable two cases to be transported together
- maximum case depth = 8" allowing up to 8 flat panels per case
- can ship UPS/FedEx or Freight

OCF

- offers the same features and benefits of the OCT in a rectangular shape

OCF2

- molded stackable shipping crate 18" deep
- heavy-duty roller bearing recessed in bridge of case
- holds 18 layers of flat panels in horizontal direction



OCF2

name	code	weight	assembled dimensions
freight case	OCFM	35 lbs.	☺ interior: 35.75" w x 9.75" h x 47.25" d exterior: 38" w x 15" h x 49" d
freight case	OCF	55 lbs.	☺ interior: 48" w x 19.75" h x 35.5" d exterior: 51" w x 24" h x 39" d
freight case	OCF2	70 lbs.	☺ interior: 48" w x 18" h x 48" d exterior: 51" w x 23" h x 51" d

ORBITAL CURVED TRUSS CASE



- designed to handle national & international exhibit freight shipments
- offers maximum protection for your exhibit materials

name	code	weight	assembled dimensions
orbital curved truss case	OCT	138 lbs.	☺ interior: 43.5" w x 33" h x 47.25" d exterior: 48" w x 42" h x 51" d





theexhibitorshandbook.ca

THE EXHIBITORS'®
HAND
BOOK
MODULAR DISPLAY SOLUTIONS