



Directional Signs Catalog



Table of Contents



Wall Signs.....1-3



Directories.....4-6



Projecting Signs.....8-9



Suspended Signs.....10-11



Triangular Signs.....12



Desk Frames.....13-15



Towers.....16-17



Pylons.....19

Sign Stands.....20-24



Snapping Signage.....25



Snap Frame Light Boxes.....26



Trappa Snap Frames.....27



Projecting Snap Frames.....28



Suspended Snap Frames.....29



Sign Anchors & Additional Sign Products...30-31



Stylish, Versatile & Affordable



SignPro Systems™ (SPS) provides affordable, modular wayfinding signage to the trade. From wall frames to self-standing pylon directories and everything in between, SignPro works with your sign professional to deliver the directional indoor signage you need. The expansive product line includes wall signs, projecting signs, directories, suspended signs, triangular signs, info centers, towers, pylons, desk signs, poster frames and much more. The Sign Makers' Handbook is your guide to a range of well-designed, user-friendly, versatile and highly cost-competitive sign solutions.

SignPro Systems (SPS) recognizes a need for more efficient service and faster delivery at a better price, and you should expect no less from us. SPS is committed to providing affordable solutions and work hand-in-hand with your sign professional to make your project a success, in the fastest possible time.

SPS frames can accommodate a multitude of sign substrates and fabrication methods, from printed paper inserts mounted with our protective lens, to laminated prints, cut vinyl, photopolymer, ADA faces, engraved plastics, metal and more. Your sign professional will help you find the products and materials that are right for your project.



The curved, aluminum body is available in anodized silver or powder-coated black finish with your choice of black or gray impact-modified plastic end caps. Comes standard with a clear, non-glare lens, unless otherwise specified. Mounting holes and tape optional. Custom lengths available.

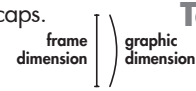

Top-to-Bottom Curve
left & right end caps

WL1 WL2 WL3 WL4 WL5 WL6 WL7 WL8	$2\frac{3}{16}''$ $2.36''$	60
WP4 WP5 WP6 WL9 WL10 WL11 WL12 WL13 WL14 WL15	$3\frac{3}{4}''$ $3.93''$	100
WL16 WL17 WL18 WL19 WL20 WL21	$4\frac{9}{16}''$ $4.72''$	120
WL22 WL23 WL24 WL25 WL26 WL27	$5\frac{3}{4}''$ $5.90''$	150
WL28 WL29 WL30 WL31 WL32 WL33	$7\frac{3}{4}''$ $7.87''$	200
WP37 WL35 WL36 WL37 WL38	$8\frac{1}{2}''$ $8.64''$	LETTER
WP41 WL40 WL41 WL42 WL43 WL44	$11\frac{1}{16}''$ $11.19''$	11
WL45 WL46 WL47 WL48 WL49 WL50 WL51	$12\frac{1}{16}''$ $12.19''$	12
WL52 WL67 WP70	$16\frac{15}{16}''$ $17.19''$	17
WL53 WP79 WP82	$17\frac{15}{16}''$ $18.19''$	18
WP85 WP86 WP87	$24''$ $24.0625''$	24



blue insert slides left & right



partition pins used to secure frame to fabric wall



All length measurements apply to the extrusion only and exclude the end caps.

Left-to-Right Curve

top & bottom end caps

The high quality, curved, aluminum body is available in anodized silver or powder-coated black finish with your choice of black or gray impact-modified plastic end caps. Comes standard with a clear, non-glare lens, unless otherwise specified. Double-sided adhesive mounting tape and holes for screw mount are optional. Our frames are ADA-compatible and can accommodate 1/16" engraved/applique lenses to comply with ADA requirements. Custom lengths available.



comes fully assembled

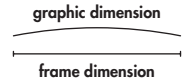

100	$3\text{--}\frac{3}{4}\text{''}$ 3.93'' $\frac{1}{2}\text{''}$ WP1	$3\text{--}\frac{1}{2}\text{''}$ 3'' WP2	4'' 4'' WP3	4.1875'' 4.1875'' $3\text{--}\frac{1}{4}\text{''}$ WP311	5'' 5'' WP4	5.1875'' 5.1875'' $3\text{--}\frac{1}{2}\text{''}$ WP411	6'' 6'' WP5	6.1875'' 6.1875'' $4\text{--}\frac{1}{2}\text{''}$ WP511	8'' 8'' WP6				
120	$4\text{--}\frac{9}{16}\text{''}$ 4.72'' $\frac{1}{2}\text{''}$ WP7	$3\text{--}\frac{1}{2}\text{''}$ $3\text{--}\frac{1}{2}\text{''}$ WP8	4'' 4'' WP9	4.1875'' 4.1875'' $3\text{--}\frac{1}{4}\text{''}$ WP91	5'' 5'' WP10	5.1875'' 5.1875'' $3\text{--}\frac{1}{2}\text{''}$ WP101	6'' 6'' WP11	6.1875'' 6.1875'' $4\text{--}\frac{1}{2}\text{''}$ WP111	7'' 7'' WP12	8'' 8'' WP13			
150	$5\text{--}\frac{3}{4}\text{''}$ 5.90'' $\frac{1}{2}\text{''}$ WP14	$3\text{--}\frac{1}{2}\text{''}$ $3\text{--}\frac{1}{2}\text{''}$ WP15	4'' 4'' WP16	4.1875'' 4.1875'' $3\text{--}\frac{1}{4}\text{''}$ WP161	5'' 5'' WP17	6'' 6'' WP18	6.1875'' 6.1875'' $4\text{--}\frac{1}{2}\text{''}$ WP181	8'' 8'' WP19	8.1875'' 8.1875'' $6\text{--}\frac{1}{2}\text{''}$ WP191	8.5'' 8.5'' WP20	9'' 9'' WP21		
200	$7\text{--}\frac{3}{4}\text{''}$ 7.87'' $\frac{1}{2}\text{''}$ WP22	4'' 4'' WP23	4.1875'' 4.1875'' $3\text{--}\frac{1}{4}\text{''}$ WP231	5'' 5'' WP24	6'' 6'' WP25	6.1875'' 6.1875'' $4\text{--}\frac{1}{2}\text{''}$ WP251	8'' 8'' WP26	8.1875'' 8.1875'' $6\text{--}\frac{1}{2}\text{''}$ WP261	10'' 10'' WP27	10.1875-- 10.1875-- $8\text{--}\frac{1}{2}\text{''}$ WP271	12'' 12'' WP28	16'' 16'' WP29	18'' 18'' WP30
LETTER	$8\text{--}\frac{1}{2}\text{''}$ 8.64'' $4\text{--}\frac{1}{4}\text{''}$ WP31	5.5'' 5.5'' WP32	6'' 6'' WP33	8'' 8'' WP34	8.1875'' 8.1875'' $6\text{--}\frac{1}{2}\text{''}$ WP341	8.5'' 8.5'' WP35	10'' 10'' WP36	10.1875-- 10.1875-- $8\text{--}\frac{1}{2}\text{''}$ WP361	11'' 11'' WP37	11.1875-- 11.1875-- $9\text{--}\frac{1}{2}\text{''}$ WP371	13.1875'' 13.1875'' $11\text{--}\frac{1}{2}\text{''}$ WP372	16'' 16'' WP38	
11	$11\text{--}\frac{1}{16}\text{''}$ 11.19'' 6'' WP40	8.5'' 8.5'' 8.5'' 11'' WP41	8.6875'' 8.6875'' $6.5\text{--}\frac{1}{2}\text{''}$ WP4111	10'' 10'' WP42	10.6875-- 10.6875-- $8.5\text{--}\frac{1}{2}\text{''}$ WP421	11'' 11'' WP43	13'' 13'' WP44	14'' 14'' WP45	17'' 17'' WP46	20'' 20'' WP47			

All length measurements apply to the extrusion only and exclude the end caps.

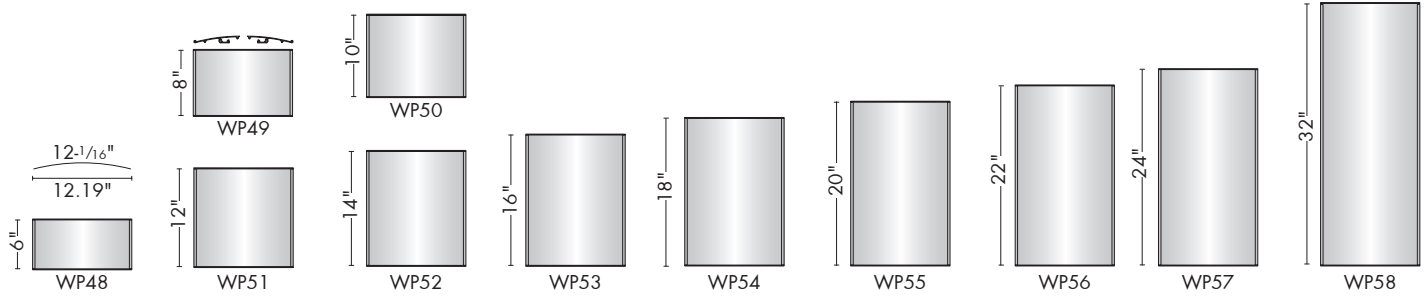

12

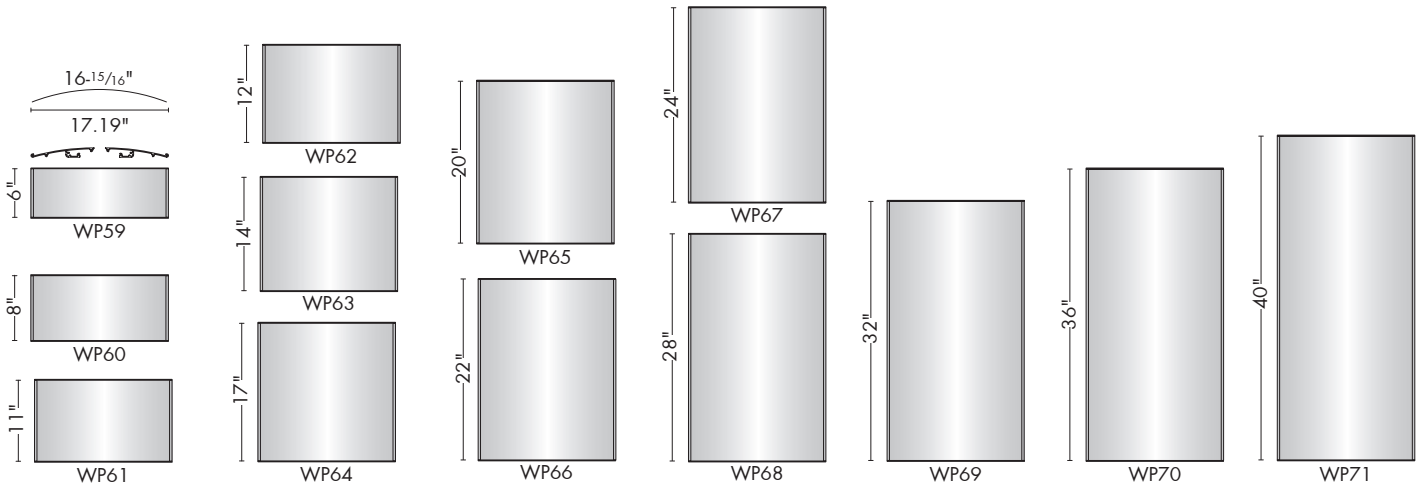

17

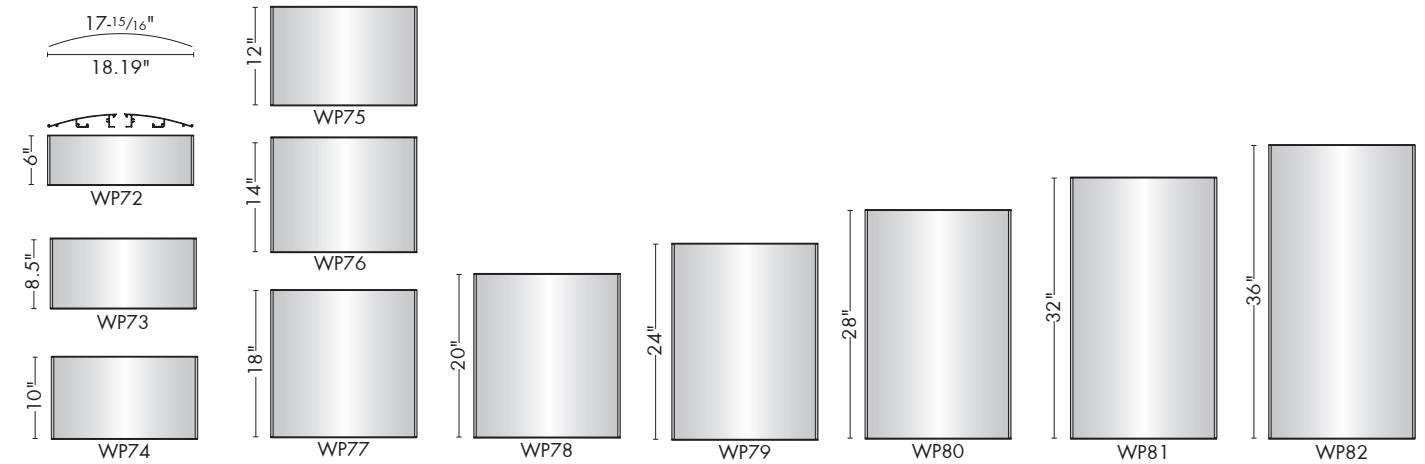

18

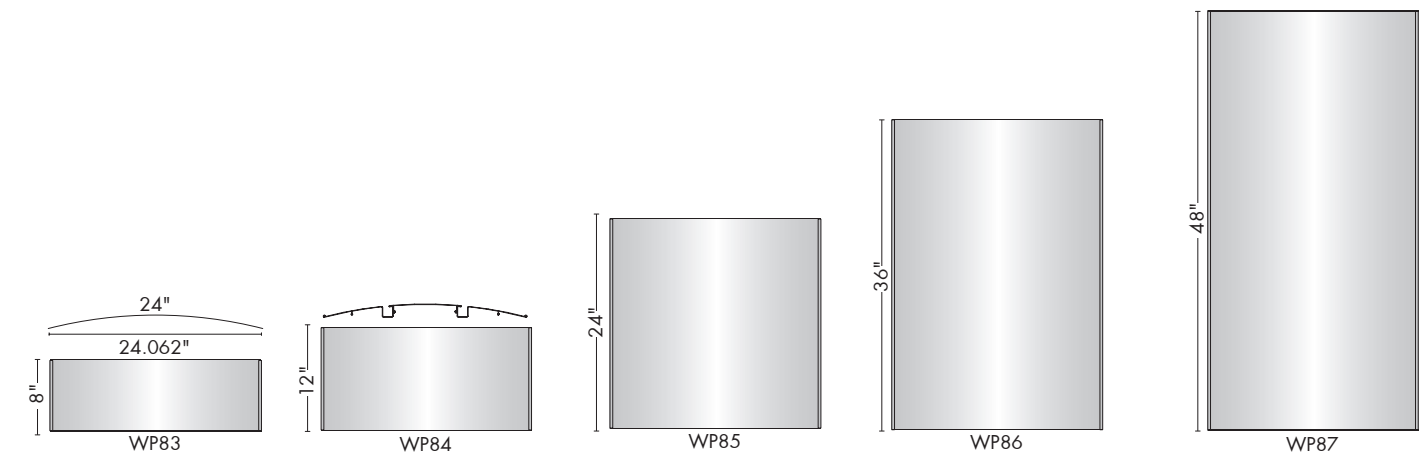

24

All length measurements apply to the extrusion only and exclude the end caps.

DIRP Series | Portrait

top & bottom end caps

The portrait style directory features dividing strips that we can adhere to the frame anywhere you'd like, breaking up your directory into as many replaceable inserts as needed. Each insert can be replaced individually. Custom frame combinations and lengths are available.

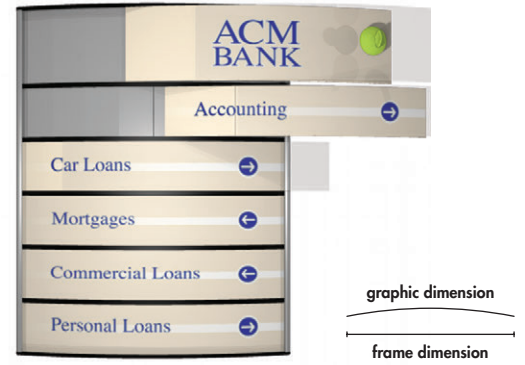

11

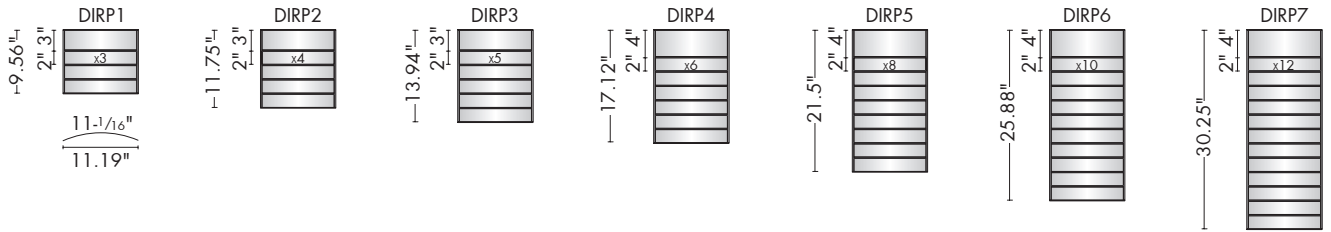

17

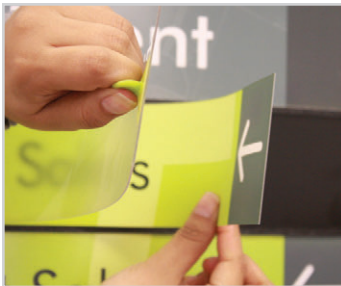
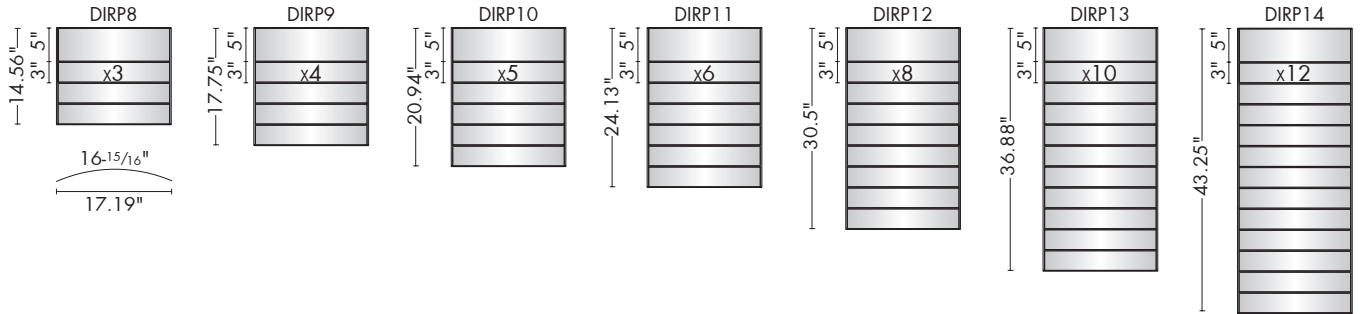

24

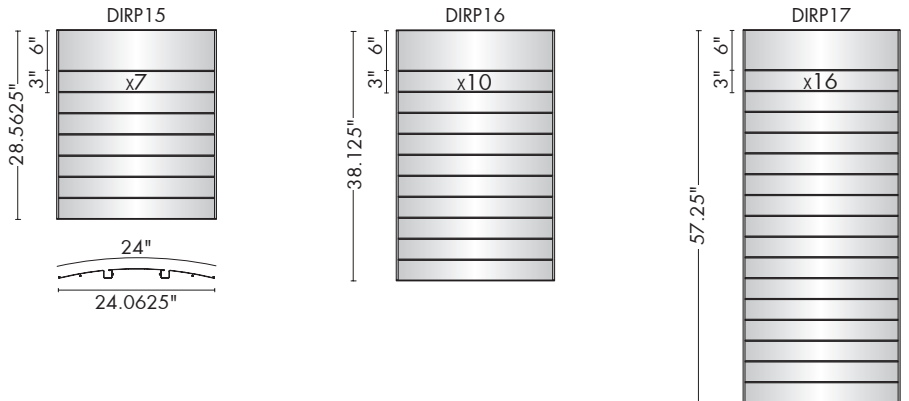

graphic is easily inserted before clear, non-glare lens

All length measurements apply to the extrusion only and exclude the end caps.



DIRM Series | Modular landscape header and vertical frames

Combine multiple vertical frames, accessorized with a top-to-bottom curve landscape header, for a custom directory look. Each of the vertical frames comes with black adhered dividing strips, allowing you to replace each insert individually. Your choice of black or gray end caps. Custom frame combinations and lengths are available.

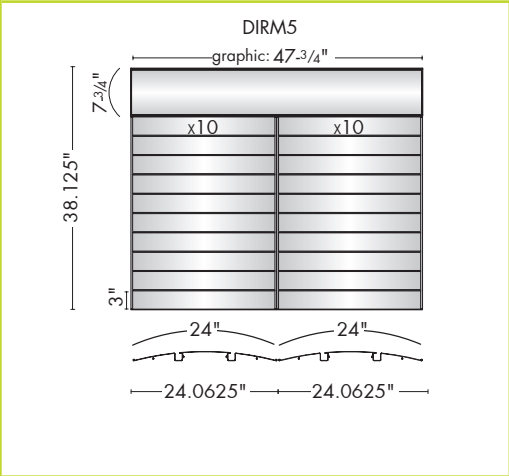
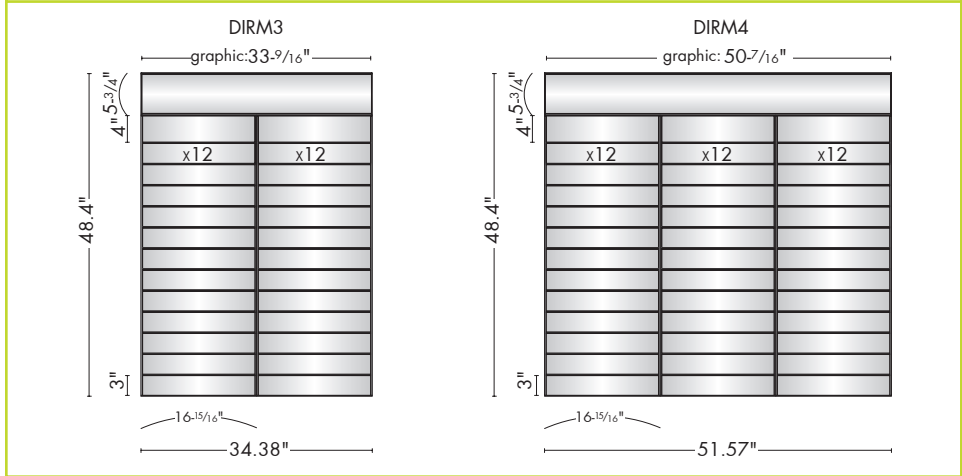
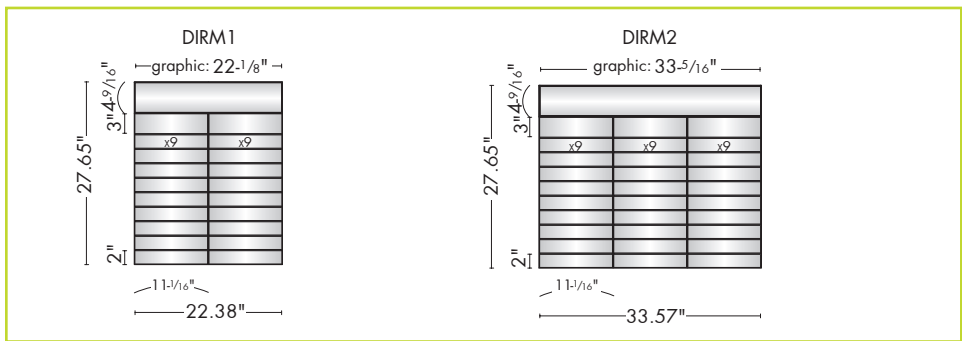

All length measurements apply to the extrusion only and exclude the end caps.

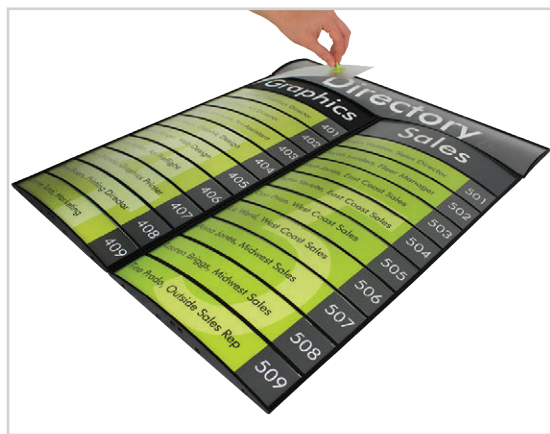

the non-glare lens is easily taken off with the suction cup for individual graphic replacement

EAST WING LEVEL 1			
←		→	
103	ADMINISTRATION	RESPIRATORY THERAPY	112
104	ADMISSIONS/CASHIER	REHABILITATION OFFICE	113
105	PATIENT RELATIONS OFFICE	PURCHASING/RECEIVING	114
106	PHARMACY	FAMILY WAITING ROOM	115
107	RADIOLOGY	ENVIRONMENTAL OFFICE	116
108	PHYSICAL THERAPY	SOCIAL SERVICES	117
109	ULTRASONOGRAPHY	GIFT SHOP	118
110	PATHOLOGY	CAFE	119
111	CT SCAN	HUMAN RESOURCES	120

DIRL Series | Landscape

left & right end caps

The DIRL line of directories consists of multiple top-to-bottom curve frames combined together and comes as a set of separate frames that mount to the wall individually, allowing you to add more frames to your display. Your choice of black or gray end caps. Custom frame combinations and lengths are available.

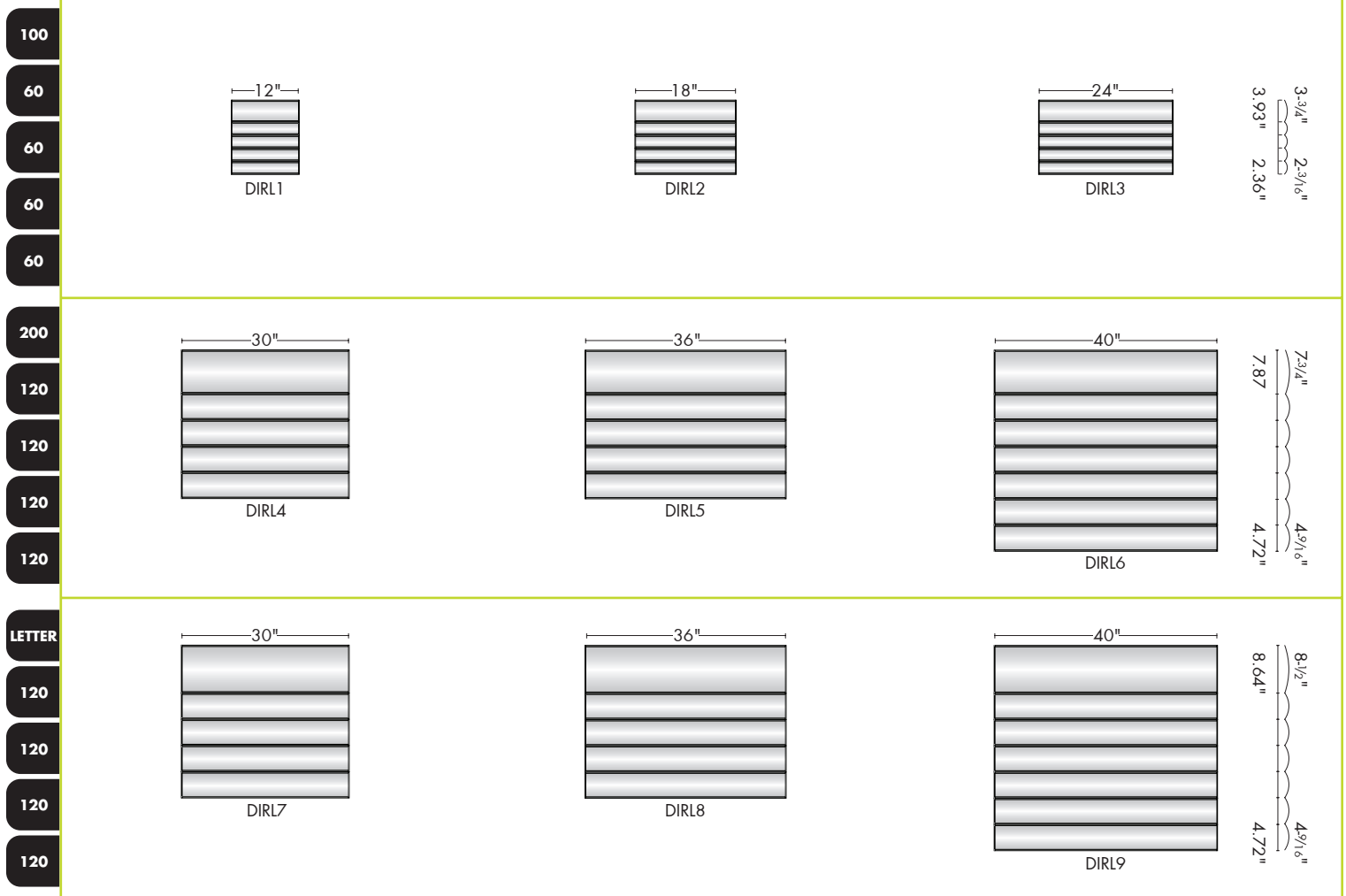

All length measurements apply to the extrusion only and exclude the end caps.

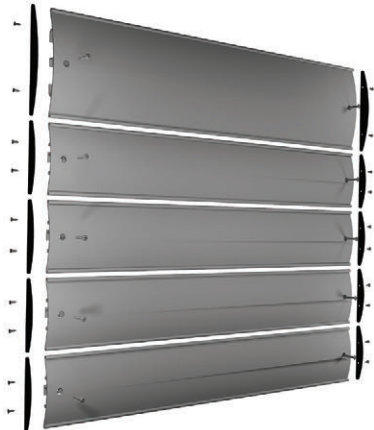

each frame allows for unique insert, available in custom widths up to 8'



the non-glare lens is easily taken off with the suction cup for individual graphic replacement

Wayfinding Signage Case Study

Community Bible Church and Christian Academy

“The result was quite a success. The signage blends in well with current décor and is clear and direct in guiding guests through our facility.”

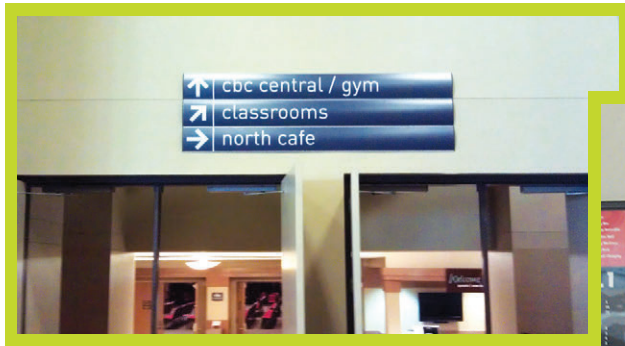

Signage Challenge

Community Bible Church and Christian Academy was in need of interior wayfinding signage to guide patrons easily through the facility. The building functions as both a school and church, therefore directional signage is vital to get visitors and patrons to the right place.

photos courtesy of Cold Fire Signs

Wayfinding Signage Case Study

North Gibson School Corporation
New Princeton Community High School

“The outcome is effective and aesthetically pleasing to everyone who visits. The signage blends well. It directly guides visitors, students and staff to their intended destinations.”

Signage Challenge

North Gibson School Corporation was in need of interior wayfinding signage for their high school to guide students, staff, and visitors to the right rooms and destinations.



photos courtesy of Signs Now #74

PJL Series | Top-to-Bottom Curve

left & right end caps

The double-sided, curved projecting frames come in landscape or portrait positions with a high quality, curved aluminum body, available in anodized silver or powder-coated black finish and your choice of black or gray impact-modified plastic end caps. Comes standard with clear non-glare lens, unless otherwise specified. Comes fully assembled. Custom lengths available.



graphic dimension (frame dimension

100	<p>PJL1</p>	<p>PJL2</p>	<p>PJL3</p>	<p>PJL31</p>
150	<p>PJL4</p>	<p>PJL5</p>	<p>PJL6</p>	<p>PJL61</p>
200	<p>PJL7</p>	<p>PJL8</p>	<p>PJL9</p>	
LETTER	<p>PJL10</p>	<p>PJL11</p>	<p>PJL12</p>	
11	<p>PJL13</p>	<p>PJL14</p>	<p>PJL15</p>	

All length measurements apply to the extrusion only and exclude the end caps.

PJP Series | Left-to-Right Curve

top & bottom end caps



PJF Series | Flat

flat projecting signs

These flat, double-sided wall projecting signs are ideally suited for cut vinyl applications. The silver finish extruded aluminum body is equipped with black impact-modified plastic end caps, one of which doubles up as a mountable bracket. Comes fully assembled. Custom lengths available.



graphic dimension
frame dimension

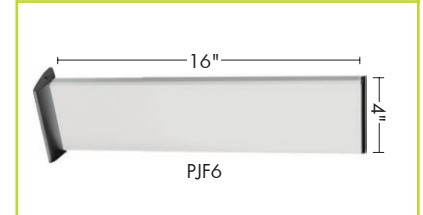
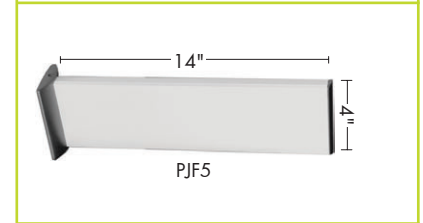
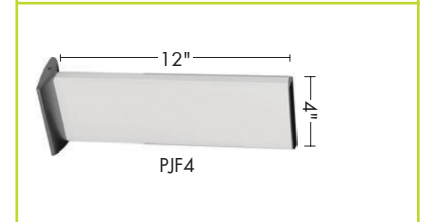
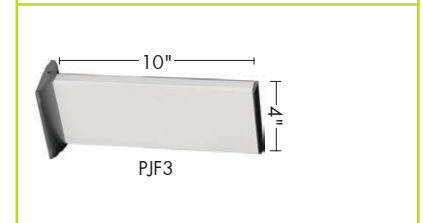
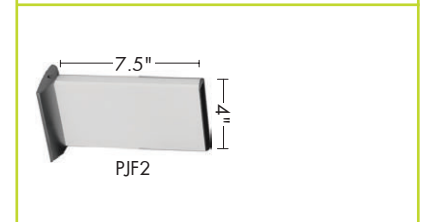
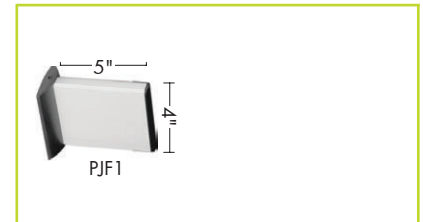
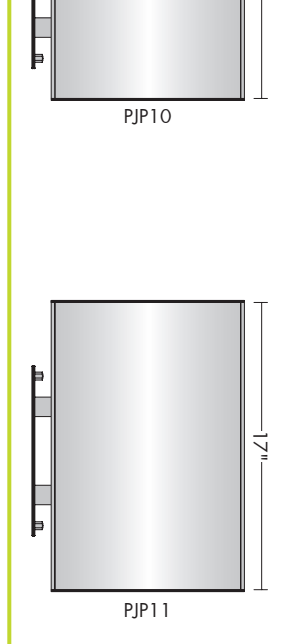
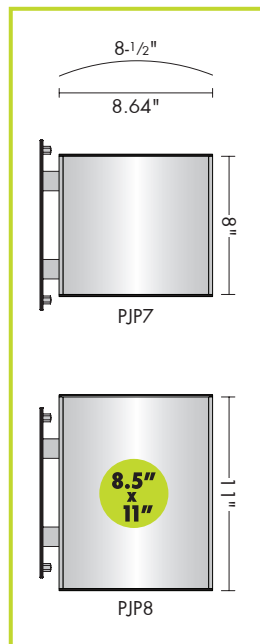
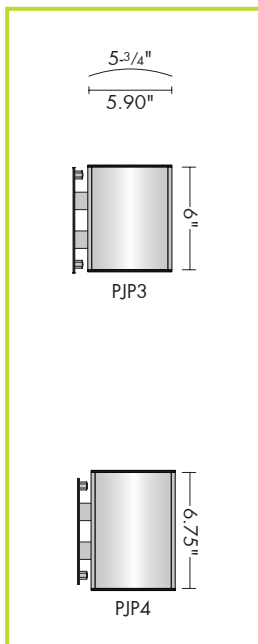
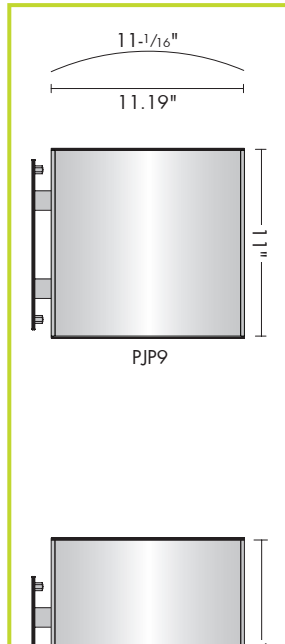
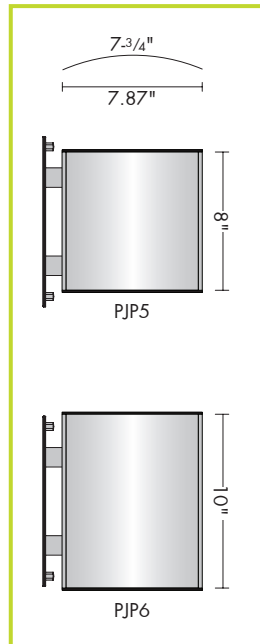
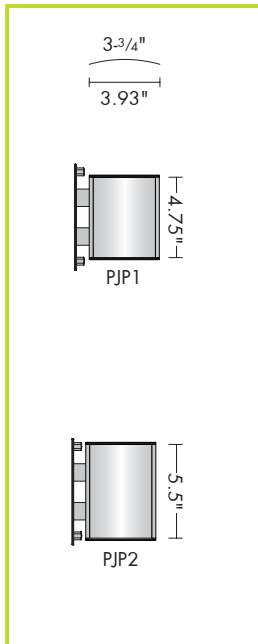

All length measurements apply to the extrusion only and exclude the end caps.

SUSP Series | Top-to-Bottom Curve

left & right end caps

This elegant, effective suspended signage solution comes in a variety of standard formats and combines sets of back-to-back extrusions. With your choice of black or gray end caps, this series comes standard with a clear, non-glare lense. Custom lengths available. Comes fully assembled.

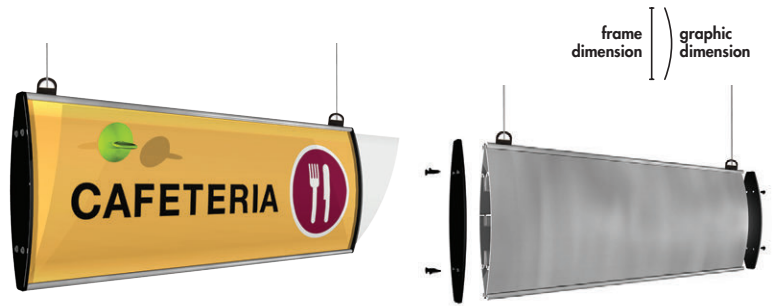

60	$2\frac{3}{16}$ " $2\frac{3}{16}$ " SUSP1 14"	 SUSP2 16"	 SUSP3 20"	 SUSP4 24"	
100	$3\frac{3}{4}$ " $3\frac{3}{4}$ " SUSP5 21"	 SUSP6 24"	 SUSP7 28"	 SUSP8 32"	
120	$4\frac{9}{16}$ " $4\frac{9}{16}$ " SUSP9 22"	 SUSP10 26"	 SUSP11 30"	 SUSP12 34"	
150	$5\frac{3}{4}$ " $5\frac{3}{4}$ " SUSP13 23"	 SUSP14 28"	 SUSP15 33"	 SUSP16 38"	
200	$7\frac{3}{4}$ " $7\frac{3}{4}$ " SUSP17 20"	 SUSP18 26"	 SUSP19 32"	 SUSP20 38"	
LETTER	$8\frac{1}{2}$ " $8\frac{1}{2}$ " SUSP21 11"	 SUSP22 20"	 SUSP23 25"	 SUSP24 40"	
11	$11\frac{1}{16}$ " $11\frac{1}{16}$ " SUSP241 14"	 SUSP242 17"	 SUSP243 24"	 SUSP244 36"	
17	$16\frac{15}{16}$ " $17\frac{1}{16}$ " SUSP245 17"	 SUSP246 24"	 SUSP247 28"	 SUSP248 36"	 SUSP249 48"

All length measurements apply to the extrusion only and exclude the end caps.

SUSP Series | Top-to-Bottom Curve

left & right end caps

<p>SUSP25 16"</p>	<p>SUSP26 24"</p>	<p>SUSP27 24"</p>	<p>2.36" 2.3/16"</p>	<p>60 60 60</p>
<p>SUSP31 26"</p>	<p>SUSP32 30"</p>	<p>SUSP33 34"</p>	<p>4.72" 4.9/16"</p>	<p>120 120</p>
<p>SUSP34 28"</p>	<p>SUSP35 34"</p>	<p>SUSP36 38"</p>	<p>5.90" 5.3/4"</p>	<p>150 150</p>
<p>SUSP40 8.5" x 11" 8.5" x 11" 11"</p>	<p>SUSP41 26"</p>	<p>SUSP42 40"</p>	<p>8.64" 8.1/2"</p>	<p>LETTER LETTER</p>
<p>SUSP46 20"</p>	<p>SUSP47 25"</p>	<p>SUSP48 30"</p>	<p>8.64" 8.1/2" 4.72" 4.9/16"</p>	<p>LETTER 120 120</p>

All length measurements apply to the extrusion only and exclude the end caps.



24" left-to-right curve



17" left-to-right curve

SUSP Series | Left-to-Right Curve

top & bottom end caps

Now available with a left-to-right curve orientation in both 24" and 17" widths, combined with the height of your choice. The silver or black curved aluminum face is combined with black or grey end caps. Comes complete with a clear, non-glare lens. Comes fully assembled.

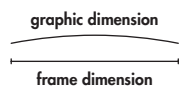

TRIANGULAR SIGNS

PJT Series | Triangular Projecting Frames

Visible from two directions, triangular projecting frames come in two silver or black aluminum curved faces and two black powder-coated steel end caps. Mounting plates come standard with both keyholes and round holes allowing for wall or ceiling mount. Available in eight standard heights. Custom lengths available.

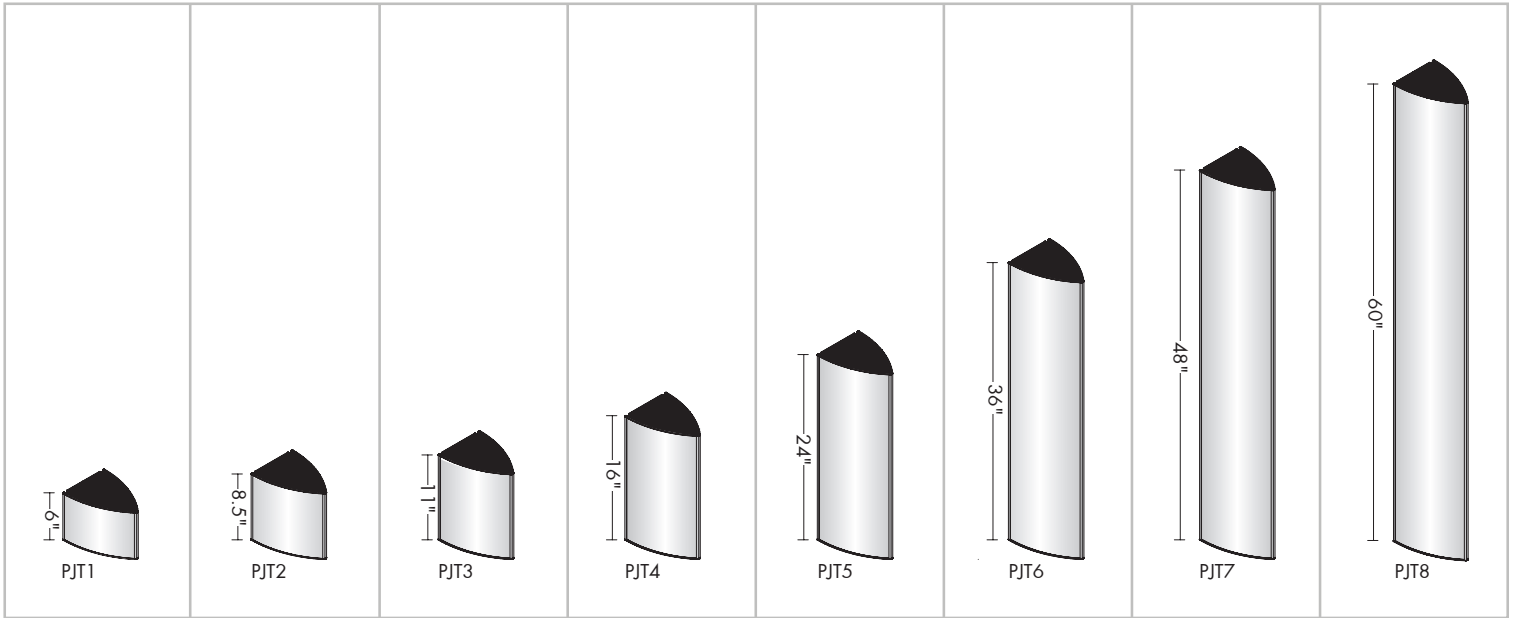

TR Series

top & bottom end caps

The triangular aluminum extruded body with impact-modified molded plastic end caps allows for wall or ceiling mount and is visible from two directions. Custom lengths available.

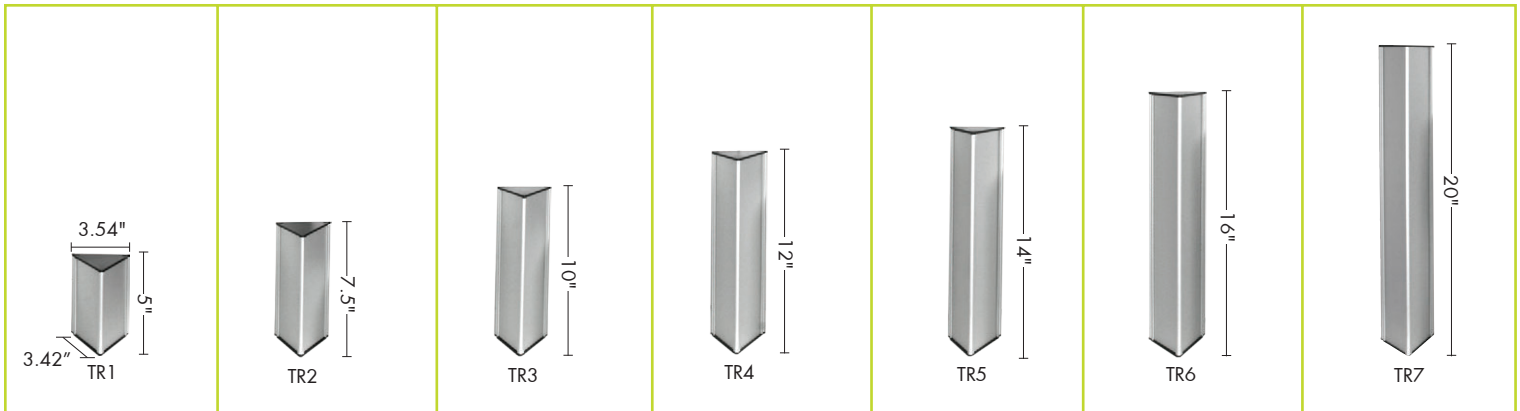
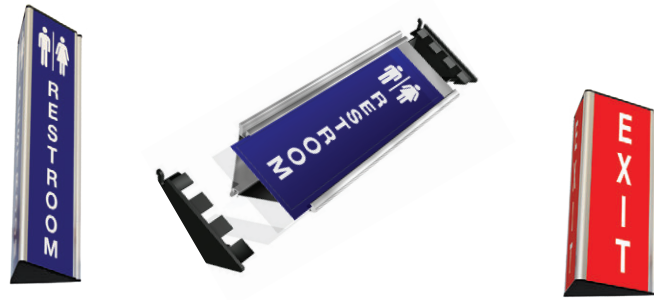

All length measurements apply to the extrusion only and exclude the end caps.

DKP Series | Left-to-Right Curved Desk Frame

The DKP series of standing desk frames consists of high quality, powder-coated black anodized silver extruded aluminum body with a black plastic top cap and black steel foot plate. Its clear, non-glare lens and suction cup come standard. Custom lengths available.

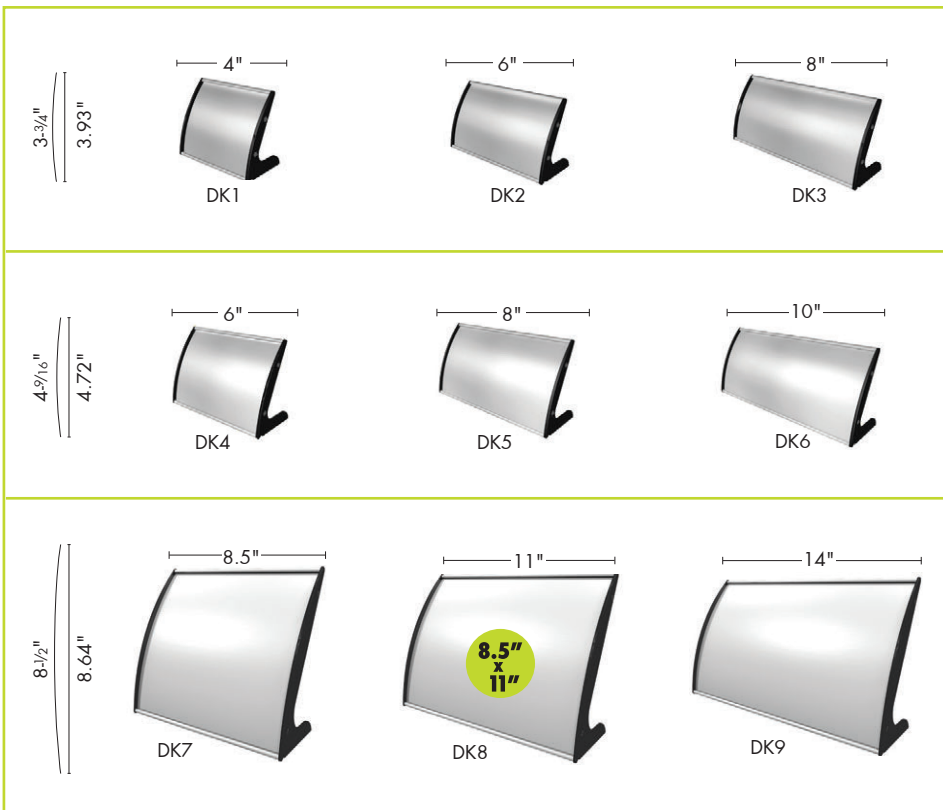
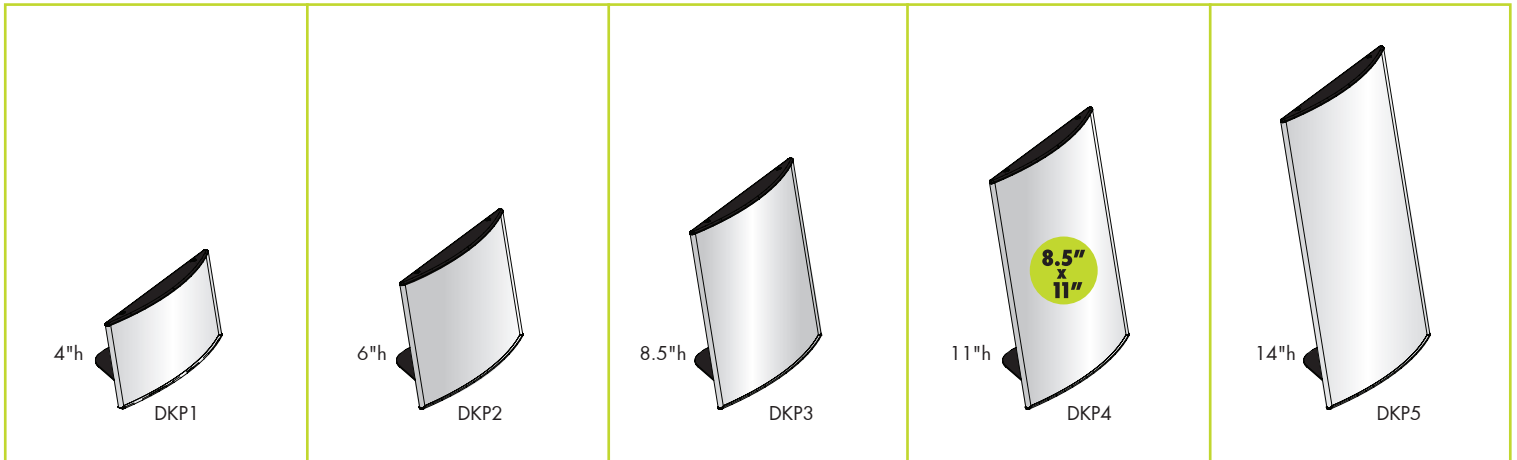
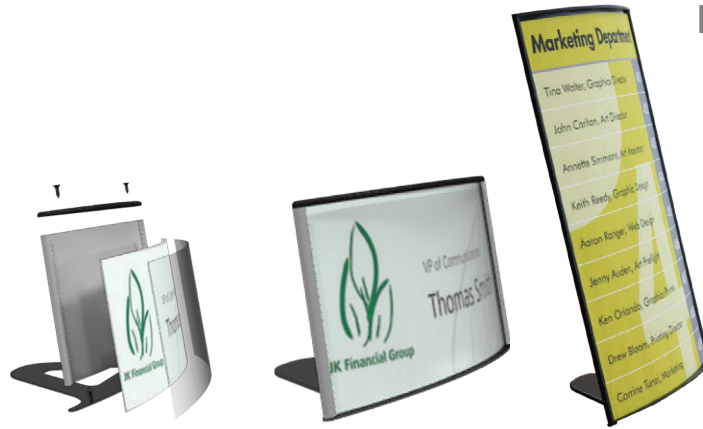
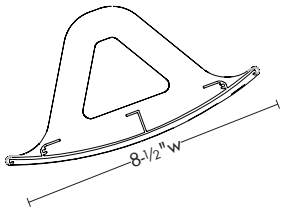

DK Series left & right end caps



The DK series of standing desk frames offers impact-modified plastic molded end caps that double as feet for desk or table top use and a high quality, extruded aluminum body with anodized silver or satin powder-coated black finish. Clear, non-glare lens comes standard. Custom lengths available.

All length measurements apply to the extrusion only and exclude the end caps.

DESK FRAMES

DKS Series

acrylic desk frames

The DKS series of standing desk frames features two clear acrylic protective plates that protect your print and brushed silver aluminum support feet for a sharp and modern look. Comes in two standard sizes.

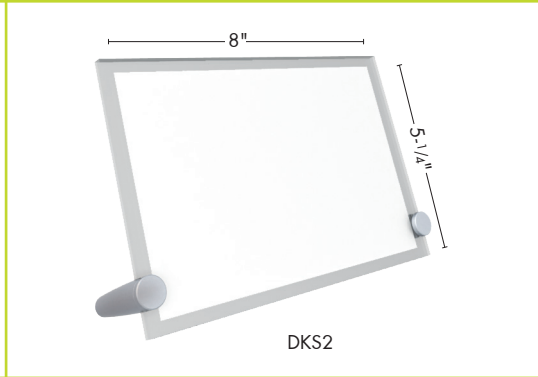
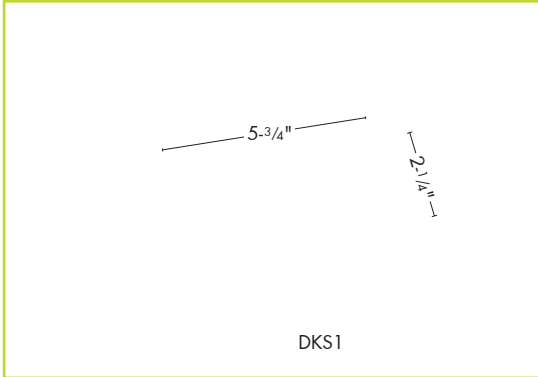

Dimensions above are graphic sizes only.



silver aluminum feet detach for easy graphic insertion

DKC Series

concave desk frames

These sleekly designed concave desk frames are constructed of high-quality extruded aluminum. The lens slides in and out for easy print replacements. Comes standard in anodized silver or satin powder-coated black finish in two standard sizes.

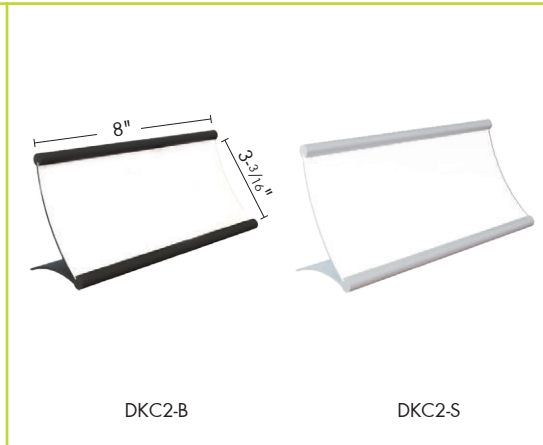
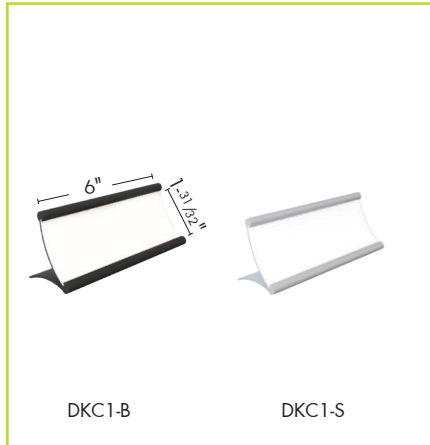
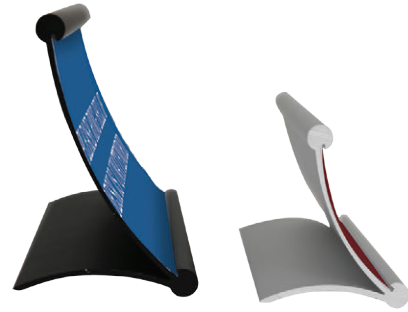

Dimensions above are graphic sizes only.

lens and graphic slide out for easy replacement

DKD Series

plexi desk frames



The DKD line of desk frames combines a stable domed, brushed silver aluminum holder with an elegant protective acrylic folded pocket providing a modern double-sided option and allows easy graphic changes. Comes in four standard sizes.

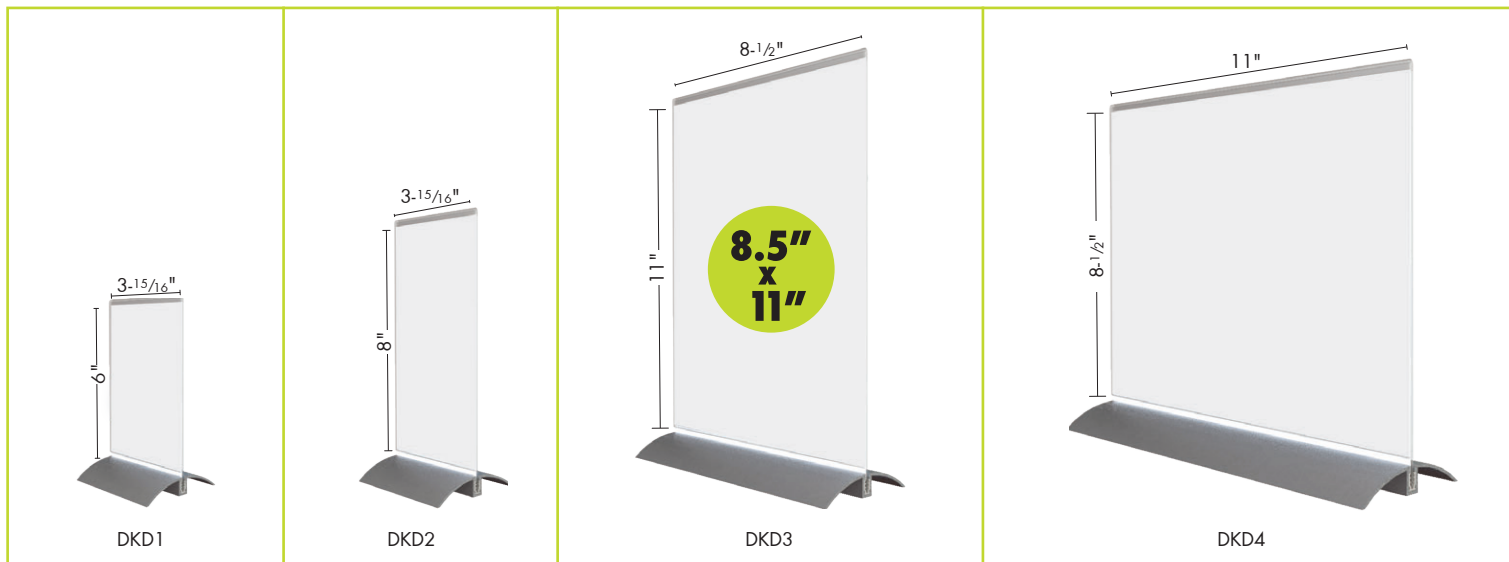

Dimensions above are graphic sizes only.

DK Snap

snap-edge desk frames

The DK Snap desk frames are available in a range of sizes and in black or silver. These front-loading desk frames snap open for quick and easy graphic changes. Includes clear non-glare protective lens.



SIZE	PORTRAIT	LANDSCAPE	# OF SUPPORT FEET
8.5" x 11"	DKSNAP-1-P	DKSNAP-1-L	1
11" x 14"	DKSNAP-2-P	DKSNAP-2-L	1
11" x 17"	DKSNAP-11-P	DKSNAP-11-L	1
12" x 18"	DKSNAP-12-P	DKSNAP-12-L	1
14" x 22"	-	DKSNAP-3-L	2
16" x 20"	DKSNAP-4-P	DKSNAP-4-L	2
20" x 24"	-	DKSNAP-5-L	2

Tri-Tower Deluxe

TRI-TOWER-DLX

This 26.75" w x 72" h free-standing modern-looking triangular display tower features durable aluminum extrusion construction coupled with rigid graphic infill panels. The convenient sliding cam locks make graphic changes quick and easy. It features a heavy duty laminated foot plate. Requires simple assembly.

frame fits three 24" w x 68.875" h graphics



the triangular shape gives dimension to three graphic sides

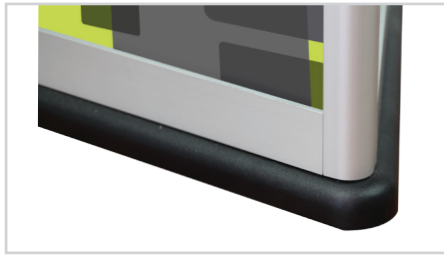

the heavy duty laminate plate strongly anchors the tower

Backlit Tower

The tower is a collapsible double-sided free-standing display featuring 24" or 33" w x 72" h "bubble" panels for maximum visibility. Simply add the optional lighting kit and turn your tower into a free-standing light box! Recommended printing material sizes are: .040" - .125". Comes with black thermoformed laminate top & bottom plates and your choice of silver or black aluminum edge extrusions. The two-part uprights disassemble, allowing the unit to collapse into the popular wheeled OCP case for easy transport. Requires simple assembly.



optional lighting kit adds an attractive element to tower and is simple to assemble



two-part uprights disassemble, allowing the unit to collapse into the popular wheeled OCP case for easy transport



add a tower lighting kit and turn it into a free-standing lightbox



Cube Tower

The Cube Tower features your choice of silver or black easy-to-use snap frames on all sides. With a variety of configurations and sizes available, the Cube Tower allows you to seamlessly display multiple graphics and messages on all four sides. The front-loading graphic mechanism makes graphic changes easy. Each frame comes with a clear protective lens. Options include wheels or feet. Custom sizes available.



wheels or feet optional

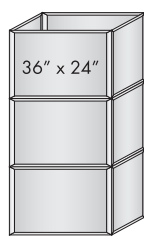

CUBE01

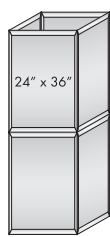

CUBE02

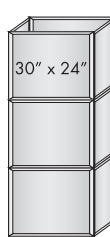

CUBE03

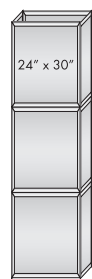

CUBE04

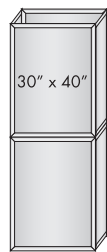

CUBE05

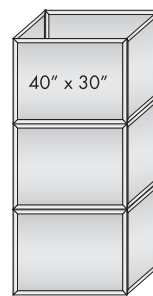

CUBE06



the rectangular shape allows for 4 different sides with multiple panels per side for graphic inserts

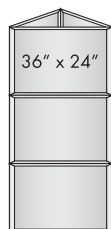

PRISM01

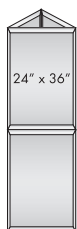

PRISM02



PRISM03



PRISM04

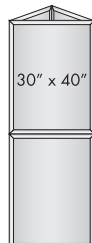

PRISM05

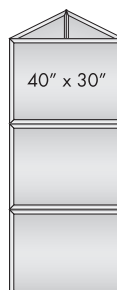

PRISM06



the triangular shape creates a 3-sided tower with multiple panels per side for graphic inserts

Prism Tower

Similar to the Cube Tower, the Prism Tower features your choice of silver or black easy-to-use snap frames on all sides. With a variety of configurations and sizes available, the Prism Tower allows you to seamlessly display multiple graphics and messages on all three sides. The front loading graphic mechanism makes graphic changes easy. Each frame comes with a clear protective lens. Options include wheels or feet. Custom sizes available.



wheels or feet optional

Wayfinding Signage Case Study

Laurel Toyota

“The results were fantastic! The professional staff of graphic designers and installers did a perfect job in all aspects of the project.”

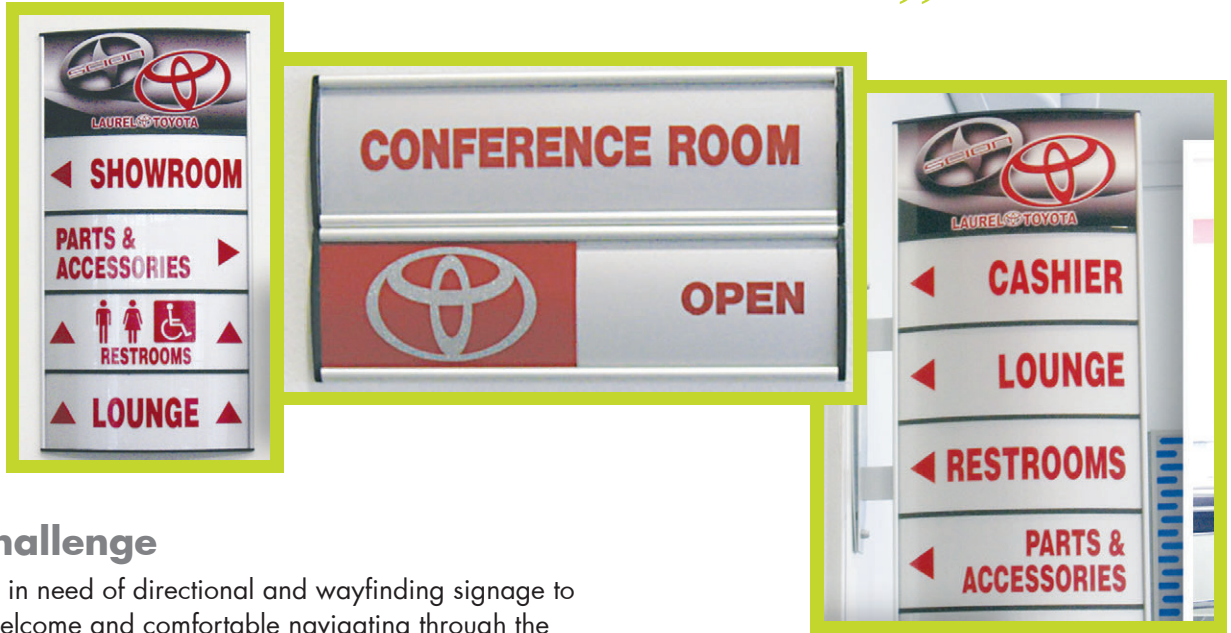

photos courtesy of Minahan Signs

Signage Challenge

Laurel Toyota was in need of directional and wayfinding signage to help clients feel welcome and comfortable navigating through the facility. Toyota was looking for an affordable solution, provided by a local contact they could constantly be in touch with.

Wayfinding Signage Case Study:

Sweet Cece's Frozen Yogurt & Treats

“We needed a quick, simple and cost-effective way to communicate yogurt and topping flavors to customers. The frames are well designed and user-friendly.”

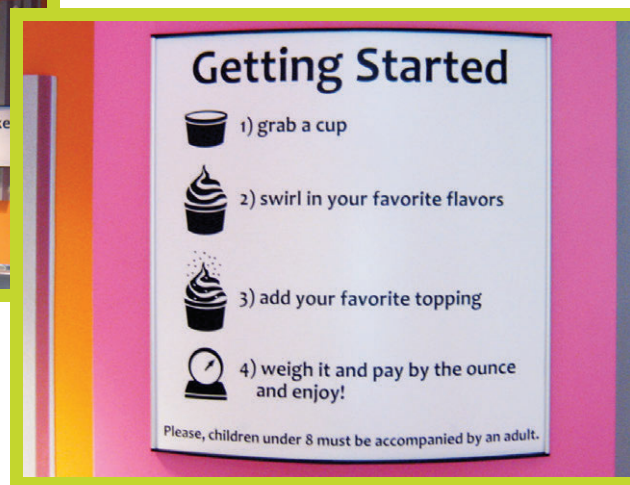

photos courtesy of 12-Point Signworks

Signage Challenge

Sweet Cece's Frozen Yogurt & Treats was in need of an easy-to-change signage option that identified its frozen yogurt flavors and topping options. As a very customer-oriented company with a friendly atmosphere, Sweet Cece's wanted its customers to feel welcome and comfortable navigating through the creation of their tasty treats.

PYL-DBL Series
double-sided pylons

These sleek and attractive free-standing pylons are sure to get the message across. When used with dividing strips, they will turn into free-standing large format directories.

PYL-TR Series
three-sided pylons



Made with a black thermoformed laminate bottom plate with robust steel support plates and a black plastic molded top plate. Finished with your choice of silver or black curved high quality aluminum extrusions. Comes with clear non-glare protective lenses that can be removed for a quick graphic change. Requires assembly.



Made with a black thermoformed laminate bottom plate with robust steel support plates and finished with your choice of silver or black curved high quality aluminum extrusions. Comes with clear non-glare lenses that can be removed for quick graphic change. The PYL-TR-1 and PYL-TR-2 come with a black powder-coated steel top plate, while the PYL-TR-3 comes with a thermoformed top plate. Requires assembly.

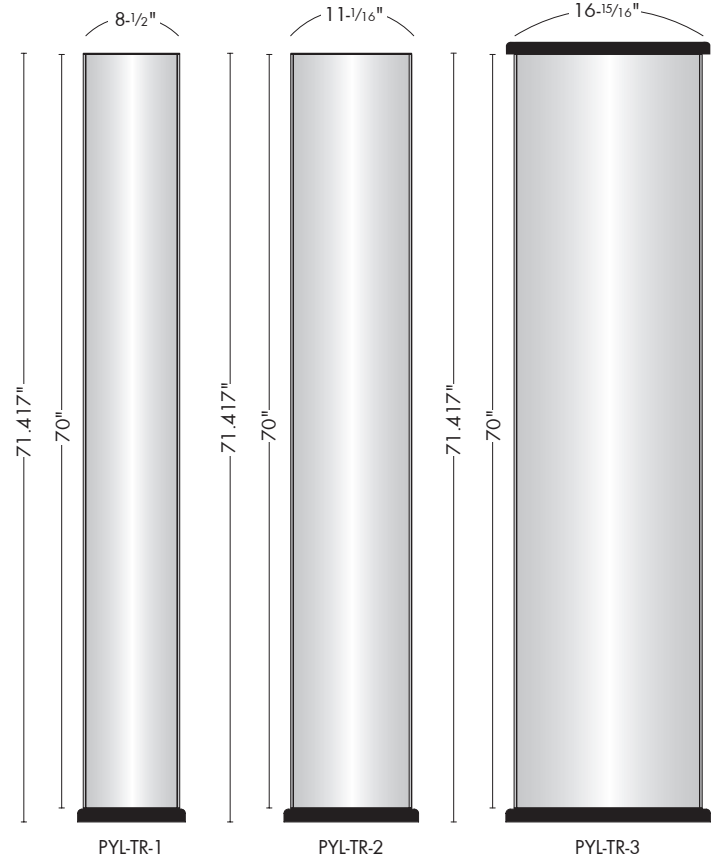
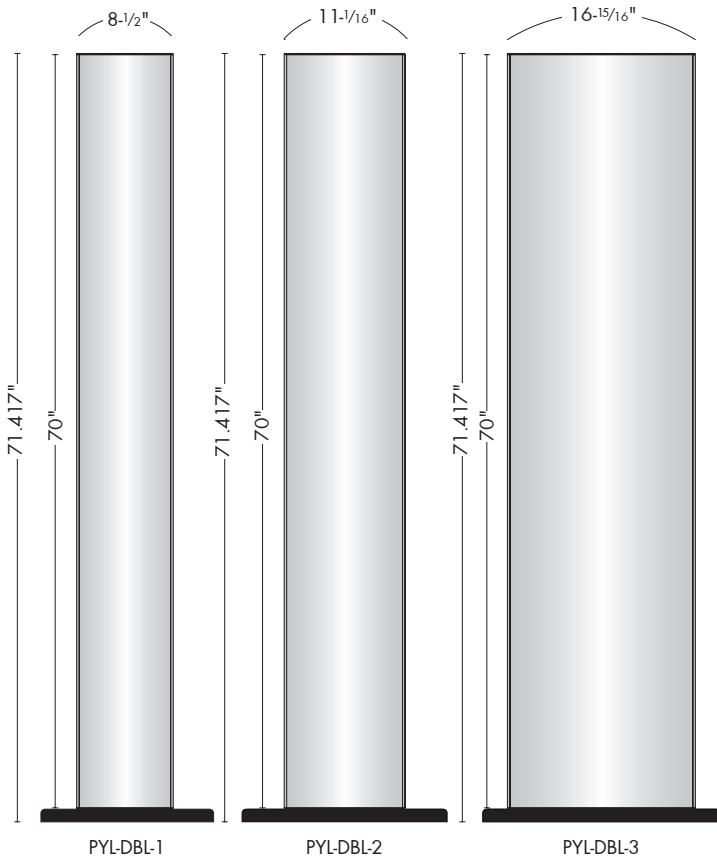
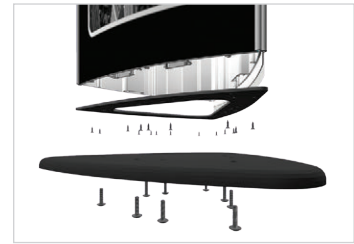

Sign Stands

versatile graphic displays

Easily display a graphic or message with a versatile and easy-to-assemble sign stand. These sleek stands are perfect to display your message. Options vary per stand – such as adjustable posts, portrait and landscape sign configurations and more.



Observe Deluxe

OBS-DLX

- Stylish double-sided curved design
- Holds two 24" w x 36" h bubble graphics
- Recommended printing material: .040"-.125" opaque styrene
- Elegant brushed silver
- Sturdy steel base with removable and adjustable brochure pockets
- 74-1/2" h



Observe Grand

OBS-G

- Sleek info center includes sturdy base & adjustable shelf
- Accepts 22" w x 28" h graphic size
- Single or double-sided
- Holds a 3/16" thick mounted graphic
- 37" h without graphic

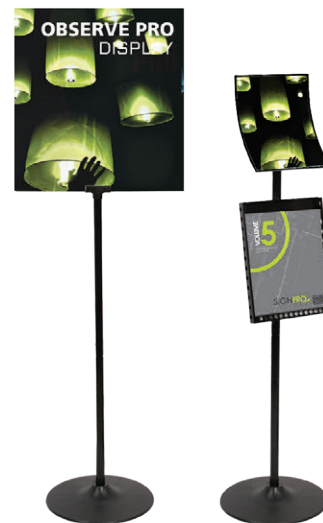

Observe Pro

OBS-LP-SYS

- Lightweight snap together info center
- 12" diameter base
- Stylish curved header
- Adjustable brochure holder
- Accepts 8.5" w x 11" h graphic and literature
- 42" h without graphic

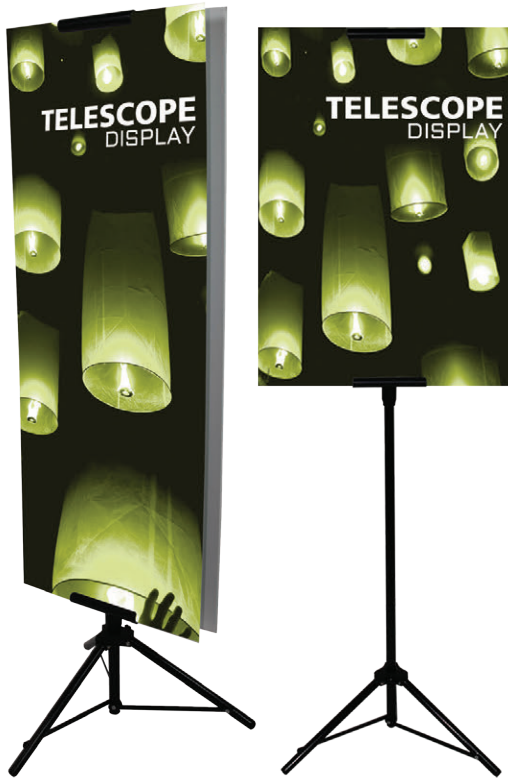

Telescope

TELESCOPE

- Tripod banner stand supports rigid graphics up to 72" tall
- Can support one or two graphics
- Gripping clamps ideal to hold corrugated plastic and foam board
- Black steel finish

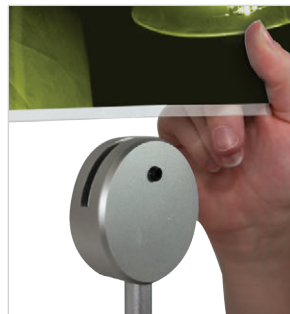

Spartan

SPARTAN

- Sleek, designer sign holder includes protective acrylic folded pocket to hold 8.5" w x 11" h literature or contour-cut rigid graphic
- Silver aluminum alloy post and circular black powder-coated base
- Add second post to hold a larger rigid graphic
- 52-1/4" h



Acclaim

ACCLAIM

- Modern, aluminum swiveling sign holder holds rigid 17" w x 11" h graphic (slides in from the top)
- Brushed silver sign holder, post and square base
- Telescopic post offers variable height from 37" - 54.5"

Sign Stands

versatile graphic displays

Easily display a graphic or message with a versatile and easy-to-assemble sign stand. We offer stands that feature adjustable posts, portrait and landscape sign configurations and more.



Snapper Stand

SNP-STAND

- Attractive, stylish snap-open 11" x 17" frame
- Portrait or landscape presentation options provided
- Mounted on silver aluminum stand
- Requires light assembly
- 40"h



Accolade

ACCOLADE

- Premium bamboo stand
- Holds 8.5" x 11" paper
- Can be used in portrait and landscape configurations
- Comes with canvas carry bag
- Telescoping post offers variable height from 33" - 51"



Advocate

ADVOCATE

- Fashionable, chrome finish, aluminum post and frame
- Holds 8.5" x 11" graphic
- Can be rotated 360 degrees or any desired angle
- Telescoping post offers variable height from 30.5" - 48"



Demonstrator

DEMONSTRATOR

- Stylish acrylic sign holder holds literature in top and bottom pockets
- Top frame can be used in landscape configuration only
- Acrylic sign holders, brushed silver post and base
- 45" h

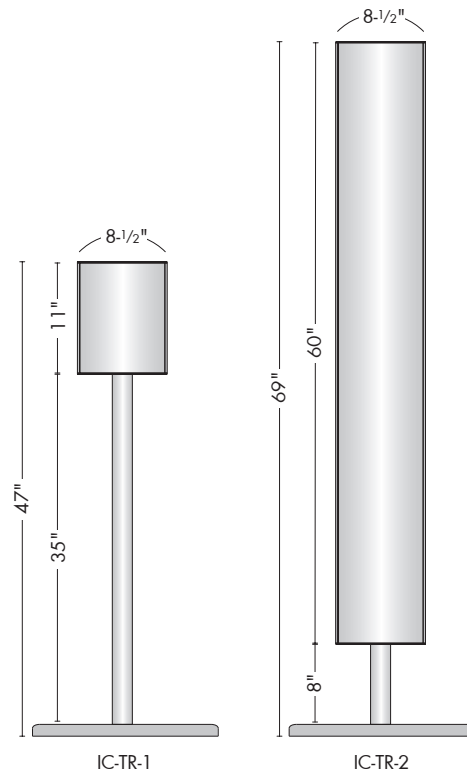

variable frame size options add versatility



IC-TR Series

IC-TR

- Silver or black curved high quality aluminum extrusions
- Silver aluminum post, silver steel domed foot plate
- Black powder-coated steel top and bottom plate
- Clear non-glare protective lenses can be removed for a quick graphic change
- Product requires assembly

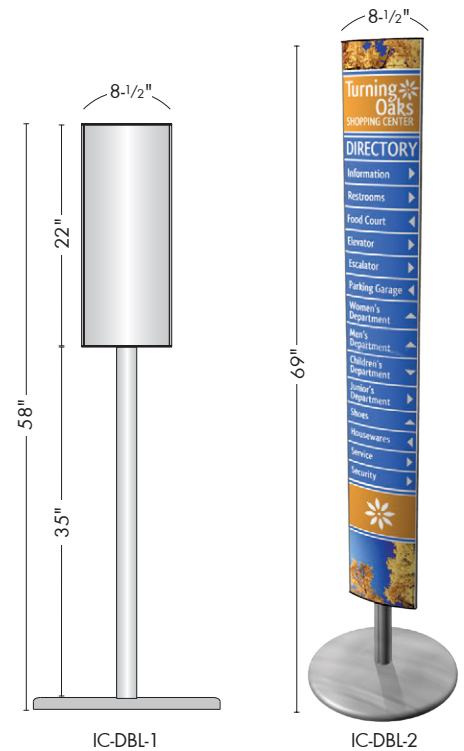

variable frame size options add versatility

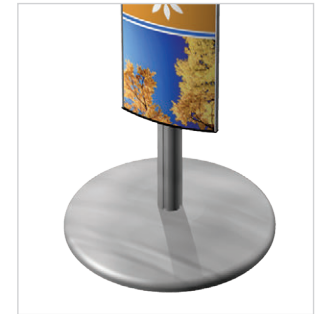

IC-DBL Series

IC-DBL

- Silver or black curved high quality aluminum extrusions
- Silver aluminum post, silver steel domed foot plate
- Black powder-coated steel bottom plate, black molded plastic top plate
- Clear non-glare protective lenses can be removed for a quick graphic change
- Product requires assembly

Trappa Post

TP

Versatile Trappa Posts feature snap sign frames and come in a variety of configurations and sizes. Sturdy aluminum posts and heavy domed steel plate ensure stability. Comes with your choice of silver or black snap frames, large or small, landscape, portrait or diagonal. The front loading graphic mechanism makes graphic changes easy. Includes clear protective lenses. Assembly required.



post connects for quick assembly

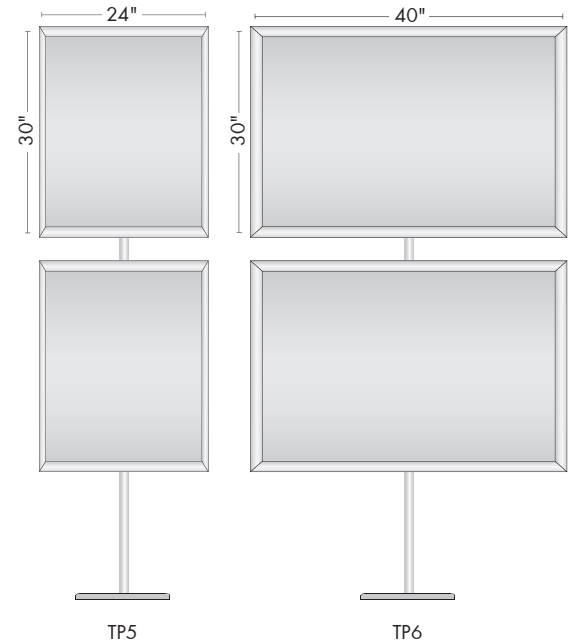
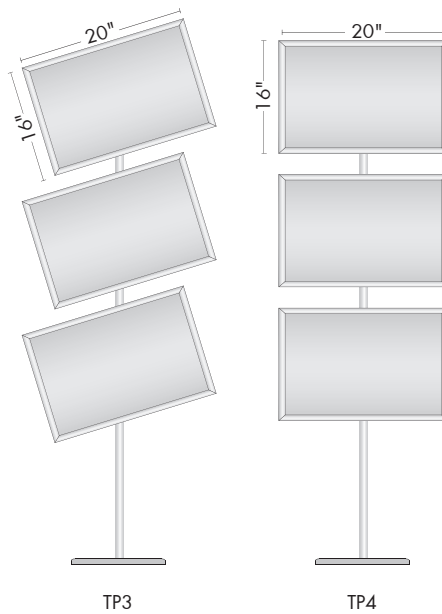
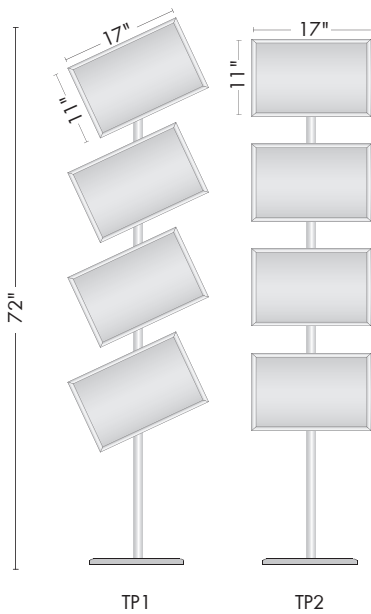

Poster Snapper



The Poster Snapper creates a clean, simple, elegant look with hanging clips that feature both a top opening for clear nylon line mount as well as a recessed pocket for S-hook suspension.

The adjustable hanging clips slide along the top rail to match your desired spacing. Rails snap open and shut for quick graphic changes. Comes in four different standard widths: 24", 30", 36" and 48". Custom-cut width available up to 60".

hanging options:

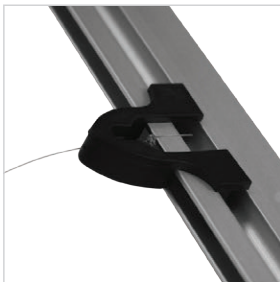

nylon line



S-hook



snap graphic rail for easy change-out

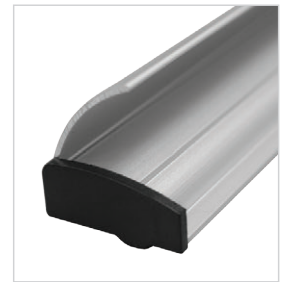

snap rail

Trappa Custom

TRP-CUSTOM

The Trappa Poster Frame offers a simple, elegant snap rail solution for your custom-sized needs. It combines two custom-length spring-loaded snap rails with a backer and a clear non-glare protective lens, allowing you to mount your custom sized print to a wall just by inserting the poster and snapping the edges shut. Rails, backer and lens are cut to size, depending on your graphic dimensions and desired rail length.



SUGGESTED POPULAR SIZES

8.5" x 11"

11" x 17"

20" x 24"

22" x 28"

24" x 36"

24" x 48"

30" x 40"

36" x 52"

Snap Frame LED Light Boxes

snap frame light boxes

Snap Frame LED Light Boxes feature an LED diffuser panel, a thin 1" profile and easy-to-use snap frames. The LED diffuser panel ensures even light distribution and brightness.

The silver frame snaps open from the front to allow quick and easy graphic changes. No tools are required. This sleek system features a set of spring-loaded aluminum extrusions mounted to a LED diffuser panel. Comes standard with clear protective lenses, fully assembled and ready to hang.

Snap Frame LED Light Boxes are ideal for permanent retail displays, corporate environments, eye-catching tradeshow graphics and more.

- 1" thick
- 50,000 hr bulb life
- Evenly distributed light
- Snap frame allows easy graphic changes
- Wall mounting hardware
- Power supply with 78" cord
- 1 year warranty



CODE	SIZE
LED-SNAP-01	16"w x 20"h
LED-SNAP-02	22"w x 28"h
LED-SNAP-03	24"w x 36"h
LED-SNAP-04	30"w x 40"h
LED-SNAP-05	36"w x 48"h



also available as hanging signs with our suspending clips



LED diffuser panel ensures even light distribution and brightness



frame snaps open from the front



translucent graphic and clear protective lens are inserted before frame snaps them securely in place



light box cord connects to wall adapter, illuminating the frame

Trappa

snap-edge wall poster frames

Trappa frame edges snap open from the front to allow quick and easy graphic changes. No tools required. This sleek framing system features a set of spring-loaded aluminum extrusions mounted to a high-impact polystyrene backer. Available in black and silver. Comes standard with clear non-glare lens, fully assembled, ready to hang.



8.5" x 11"
TRP2-1

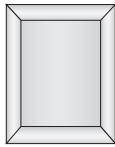

11" x 14"
TRP2-2



11" x 17"
TRP2-11



12" x 18"
TRP2-12

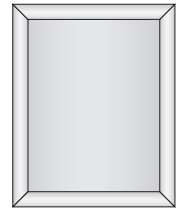

16" x 20"
TRP2-4



18" x 24"
TRP2-10

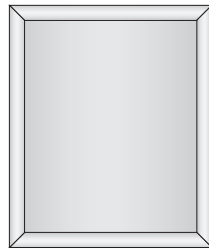

20" x 24"
TRP2-5

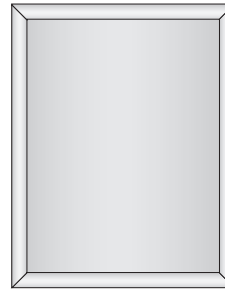

22" x 28"
TRP2-7



24" x 30"
TRP2-8



24" x 36"
TRP2-6



30" x 40"
TRP2-9

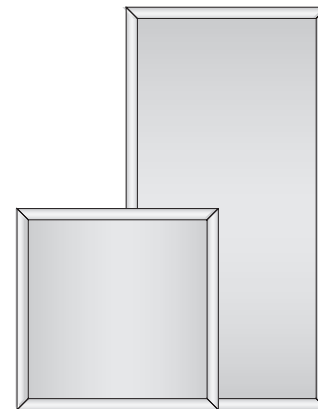

custom sizes available



Dimensions above refer to size of printed graphic only.

PJ Snap

double-sided projecting snap frames

Available in a wide range of sizes in black or silver, these double-sided projecting snap frames come standard with clear non-glare lenses, fully assembled. The spring-loaded edges allow easy graphic changes. Just remove the lens, insert a new print and snap the edges shut.

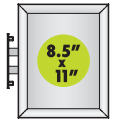
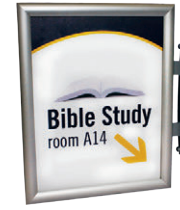

8.5" x 11"
PJSNAP-1-P

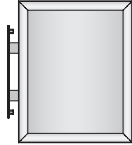

11" x 14"
PJSNAP-2-P

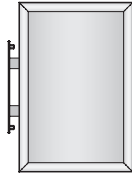

11" x 17"
PJSNAP-11-P

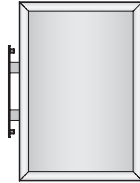

12" x 18"
PJSNAP-12-P

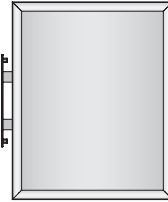

16" x 20"
PJSNAP-4-P

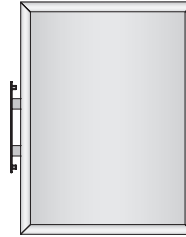

18" x 24"
PJSNAP-10-P

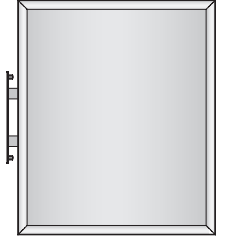

20" x 24"
PJSNAP-5-P

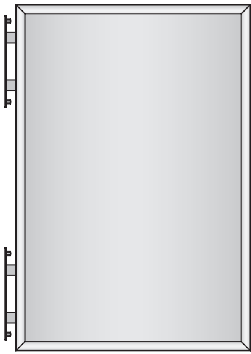

24" x 36"
PJSNAP-6-P

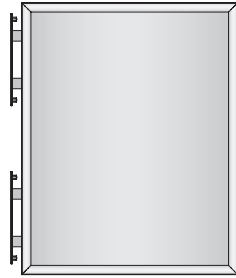

22" x 28"
PJSNAP-7-P

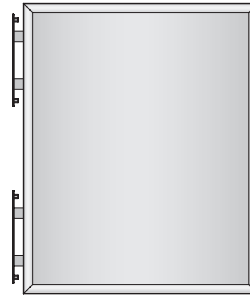

24" x 30"
PJSNAP-8-P

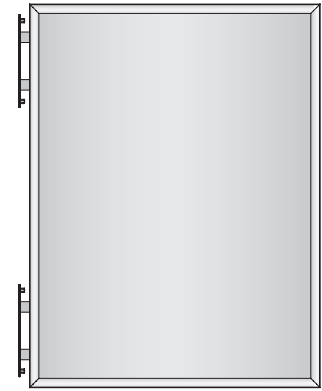

30" x 40"
PJSNAP-9-P



11" x 8.5"
PJSNAP-1-L

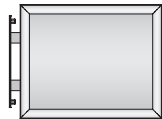

14" x 11"
PJSNAP-2-L



17" x 11"
PJSNAP-11-L



18" x 12"
PJSNAP-12-L

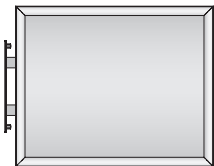

20" x 16"
PJSNAP-4-L



18" x 24"
PJSNAP-10-L

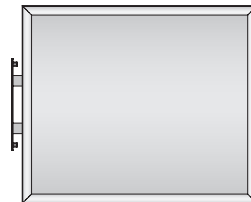

24" x 20"
PJSNAP-5-L



36" x 24"
PJSNAP-6-L

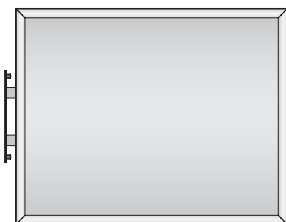

28" x 22"
PJSNAP-7-L

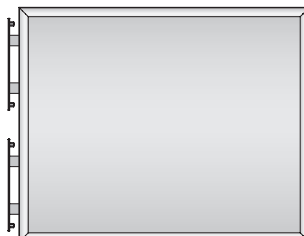

30" x 24"
PJSNAP-8-L



40" x 30"
PJSNAP-9-L

SUSP Snap

double-sided suspended snap frames

Available in a wide range of sizes in black or silver, these double-sided suspended snap frames come standard and fully assembled with clear non-glare lenses.



8.5" x 11"
SUSPSNAP-1-P

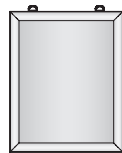

11" x 14"
SUSPSNAP-2-P



11" x 17"
SUSPSNAP-11-P



12" x 18"
SUSPSNAP-12-P

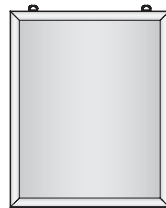

16" x 20"
SUSPSNAP-4-P



18" x 24"
SUSPSNAP-10-P



20" x 24"
SUSPSNAP-5-P



24" x 36"
SUSPSNAP-6-P



22" x 28"
SUSPSNAP-7-P



24" x 30"
SUSPSNAP-8-P

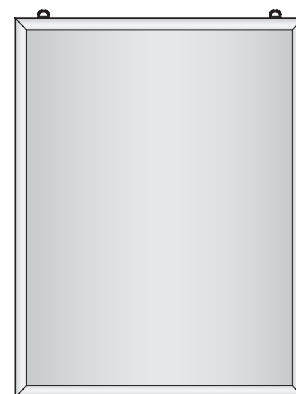

30" x 40"
SUSPSNAP-9-P

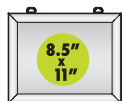

11" x 8.5"
SUSPSNAP-1-L

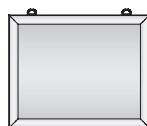

14" x 11"
SUSPSNAP-2-L

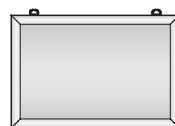

17" x 11"
SUSPSNAP-11-L



18" x 12"
SUSPSNAP-12-L

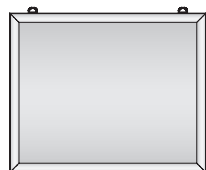

20" x 16"
SUSPSNAP-4-L



18" x 24"
SUSPSNAP-10-L

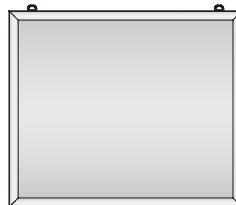

24" x 20"
SUSPSNAP-5-L

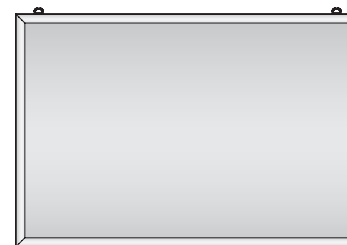

36" x 24"
SUSPSNAP-6-L

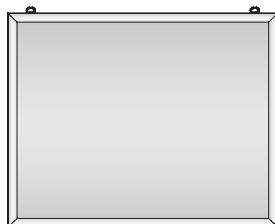

28" x 22"
SUSPSNAP-7-L



30" x 24"
SUSPSNAP-8-L

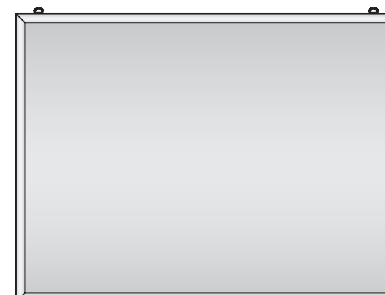

40" x 30"
SUSPSNAP-9-L

Vector Frame Edge Fabric Poster System

poster frames

- Slim, lightweight 3/4" aluminum frame
- Easy-to-apply push-fit fabric graphics
- Wall mounting hanging bracket included
- Custom frame sizes available

SQUARE

CODE	SIZE
VFE-S-01	11.8"w x 11.8"h
VFE-S-02	23.62"w x 23.62"h
VFE-S-03	35.43"w x 35.43"h
VFE-S-04	47.24"w x 47.24"h
VFE-S-05	59.06"w x 59.06"h

RECTANGLE

CODE	SIZE
VFE-R-01	11.8"w x 23.62"h
VFE-R-02	11.8"w x 35.43"h
VFE-R-03	23.62"w x 35.43"h
VFE-R-04	23.62"w x 47.24"h



Ambassador

AMBASSADOR

- Eye-catching and effective magnetic name tag
- Front curved face, equipped with a clear protective lens
- Magnetic backer secures tag in place without any damage to garment
- Silver finish
- Lightweight ABS construction
- Graphic dimensions: 2-15/16"w x 1-1/4"h



magnetic hardware secures tag in place



protective lens and graphic slide out

Atlas

ATLAS

- Outdoor sign holder
- Recommended graphics: 10mm corrugated plastic or 1/2" rigid substrates
- Use as many as you need to hold a large rigid graphic 1/2" thick
- Quick set-up, easy storage
- Hollow plastic base can be filled with water or sand
- Securely holds a Zoom 3, 4 or 5 outdoor flag pole with Zoom pin attachment
- Extend three swivel feet and stake to the ground for increased stability in windy conditions
- Ground stakes included



swivel feet allow for increased stability

Ace

ACE

- Sturdy double-sided powder coated steel "A-frame" sidewalk sign
- Rigid graphics slide in from top
- Comes with elegant brushed silver carry handle
- Designed for 24"w x 36"h rigid graphics

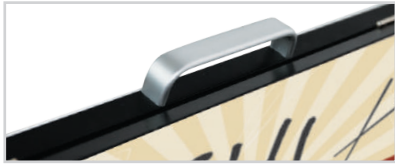

Air Dancer®

BLUE: INF-AD-10-B; INF-AD-18-B

RED: INF-AD-10-R; INF-AD-18-R

RED, WHITE & BLUE: INF-AD-18-RWB

- available in 10' and 18' heights
- non-rip nylon based material with added tarpaulin for flex
- inflates easily with use of air blower
- blower for 18' Air Dancer includes 3 adjustable speeds for varying movement levels
- base footprint is under 2', ideal for use in high-traffic areas



Navigator

NAVIGATOR

- Free-standing outdoor portable sign stand
- Visual graphic area = approx. 12.8"w x 14.8"h
- Hollow plastic base can be filled with water or sand
- Easy three-piece assembly
- Packs flat into box
- Stands 47"h



Wedge

WED-1-B

- Combine multiple units for longer and taller displays
- Graphic size is variable
- Black only
- Graphics not included



Apex

APEX

- Double-sided high impact polystyrene "A-frame" sign
- Can be printed directly on the plastic for a smooth look
- For indoor or outdoor use
- Designed for 24"w x 42"h graphic

